

**Product Description:**

- Ultrasonic sensor enables distance adjustment via the teaching wire teaching method, supporting single-point mode and window mode with simple configuration.

**Product features:**

- Support analog output
- A1/A2 points can be learned
- Temperature compensation, Small blind area



Type	Distance	Output	Connection
UKS350-G18-VP7L-Q12	20 ... 350 mm	PNP	M12 connector
UKS350-G18-VN7L-Q12	20 ... 350 mm	NPN	M12 connector

**TECHNICAL SPECIFICATION**

VOLTAGE	20 ... 30 V DC	ANGLE	± 7°
ADJUSTMENT RANGE	30 ... 350 mm	SENSOR FREQUENCY	About 200 KHz
BLIND ZONE	0 ... 30 mm	PROTECTION CIRCUIT	Reverse Polarity Protection Transient Overvoltage Protection
STANDARD INSPECTION PLATE	100 x 100 mm	WORK TEMPERATURE	-25 °C ... 70 °C
OUTPUT	PNP / NPN	STORAGE TEMPERATURE	-40 °C ... 85 °C
RESOLUTION	0.34 mm	INDICATOR LIGHT	Red LED Light on:No target is detected in the learning state Flashing:target is detected in the learning state Yellow LED Light on:A target is detected with in the range of A1-A2 Flashing:A target is detected in learning mode
REPEATABILITY	0.03 % of full scale value		
TEMPERATURE DRIFT	0.05 %/°C		
LINEARITY	< 1%		
PROTECTION CLASS	IP67		
HOUSING MATERIAL	Copper nickel plated		

**DIMENSIONS**

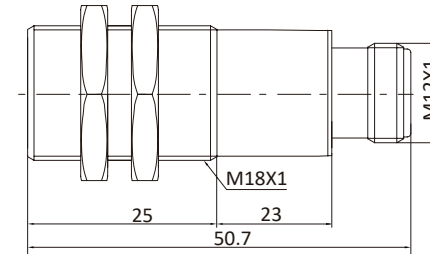

**LINE SEQUENCE COLORS AND DEFINITIONS**

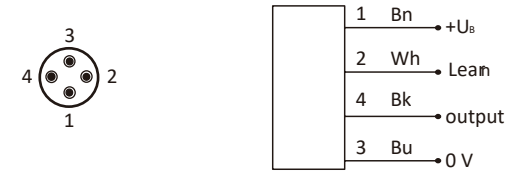

**RESPONSE CHARACTERISTICS CURVE**

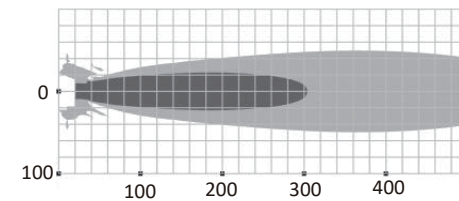

Dark colour: 25mm diameter PVC pipe  
Light colour: 100mm\*100mm flat plate  
Note: There may be deviation,for reference only

产品说明:

- 超声波传感器，通过学习线示教方式可进行距离调节，支持单点模式，窗口模式，设置简单。

产品特点:

- 支持模拟量输出
- 可学习A1/A2点
- 温度补偿，盲区小



型号	检测距离	输出方式	连接端口
UKS350-G18-VP7L-Q12	30 ... 350 mm	PNP	M12连接器
UKS350-G18-VN7L-Q12	30 ... 350 mm	NPN	M12连接器

技术参数

电压	20 ... 30 V DC	角度	± 7°
调节范围	30 ... 350 mm	传感器频率	约200 KHz
盲区	0 ... 30 mm	保护电路	防反接保护 瞬时过压保护
标准检测板	100 x 100 mm	工作温度	-25 °C ... 70 °C
输出方式	PNP / NPN	储存温度	-40 °C ... 85 °C
分辨率	0.34 mm	指示灯	红灯 常亮:未检测到目标 闪烁:学习状态下未检测到目标 黄灯 常亮:检测到目标在A1-A2范围内 闪烁:学习状态下检测到目标
重复精度	0.03 %满量程值		
温度漂移	0.05 %/°C		
线性度	< 1%		
防护等级	IP67		
外壳	铜镀镍		

外型尺寸

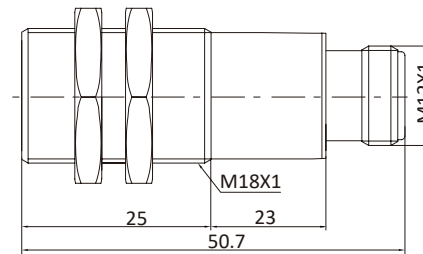

接口定义和接线图

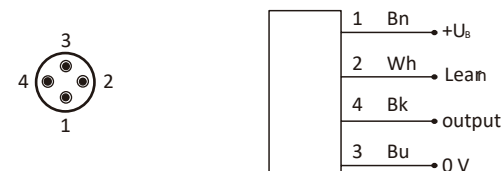

响应特性曲线

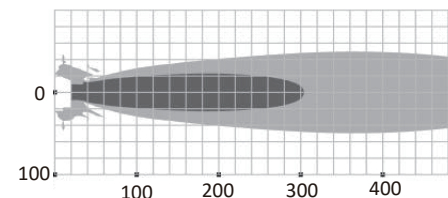

深色：直径25mmPVC管；浅色：100 x 100 mm平板  
条件：24V电源，常温，实际可能存在偏差，仅供参考

## SETTING DETECTION RANGE

Factory Settings: Default Ascending mode, A1=30mm; A2=350mm

A1: The minimum output corresponds to the distance point

A2: The maximum output corresponds to the distance point

Working mode: A1 and A2 can be learnt individually, and the working mode can be selected by setting the position of A1 point and A2 point, and the working modes are as follows 5 kinds:

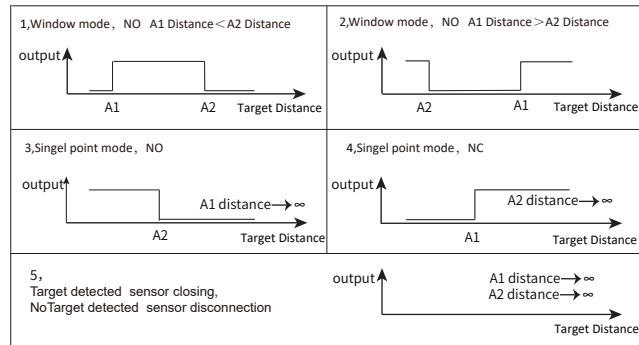

note: A1 or A2 distance  $\rightarrow \infty$ , Indicates no target detected during learning (red light on)

First, the sensor is powered on, and the green indicator behind the sensor will light up ◦

Set A2 point:

- 1) Place a measured object where the distance needs to be set.
- 2) Connect the white line (learning line) and the brown line (positive power supply) together. During this period, if the measured object is captured, the blue light keeps flashing. After this state lasts for two to three seconds, remove the white line, A2 is set successfully, and if the target is not detected during the setting, the red light will turn on.

Set A1 point:

- 1) Place a measured object where the distance needs to be set.
- 2) Connect the white line (learning line) to the blue line (negative power supply) and repeat the above steps.

Note: In order to ensure the best accuracy and system stability, please try not to set the A1 and A2 points within 20mm of the blind area. The learning mode takes effect within 5 minutes of being powered on. After 5 minutes, you need to power it on again to learn.

## INSTALLATION AND PRECAUTIONS

- 1) Due to the directional nature of ultrasonic sensors, the mounting position needs to be taken into account. It is recommended that the mounting position be perpendicular to the object to be measured in order to obtain a better relative accuracy.
- 2) Do not supply voltages other than the normal operating voltage to avoid burnout of the proximity switch.
- 3) Avoid pulling on the proximity switch lead wires to prevent damage to the electrical connections of the proximity switch.
- 4) Do not cover the surface of the sensor probe to avoid affecting the detection range of the sensor.
- 5) Use the supplied mounting nut to fix the sensor in place, avoid using other non-standard clamping devices to fix the sensor to ensure good sensitivity.
- 6) The sensor should be used to avoid strong mechanical vibration, the working environment should not have strong electromagnetic interference and rapid air circulation.
- 7) Please do not privately disassemble the sensor, such as the sensor does not work properly, please contact with the after-sales solution in a timely manner, private disassembly of all the consequences caused by the company will not be liable.

## 设置检测范围

出厂设置：默认窗口模式，常开，A1=30 mm，A2=350mm。

A1：目标距离从近及远，经过A1点，开关由断开到闭合。

A2：目标距离从远及近，经过A2点，开关由闭合到断开。

工作模式：

A1,A2可单独学习，通过设置A1点，A2点位置，可选择工作模式，工作模式共以下5种：

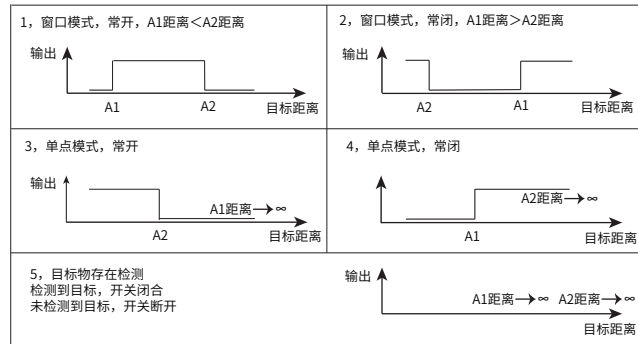

注：A1或A2距离  $\rightarrow \infty$ ，表示学习时，未检测到目标（红灯亮）

首先传感器通电，

设置A2点：

1) 在需要设定距离的地方放置一个被测物

2) 将白线（学习线）和棕线（电源正）接在一起，在此期间，如果被测物被捕捉到了，黄灯一直闪烁，此状态持续2-3s以后，把白线拿开(先移开学习线后断电，否则可能学习失败) A2设置成功，如果设定期间未检测到目标则红灯闪。

设置A1点：

1) 在需要设定距离的地方放一个被测物。

2) 将白线（学习线）与蓝线（电源负）连接，重复上述步骤即可，注意为保证最好的精度和系统稳定性，请尽量不要把A1、A2点设置在距离盲区20mm以内，学习模式在上电5分钟内有效，超过5分钟需要重新上电才能学习。

## 安装及注意事项

- 1) 由于超声波传感器具有方向性，所系需要注意安装位置。建议安装位置和被测物垂直以获得更好的相对精度。
- 2) 请不要输出正常工作电压以外的电压以避免接近开关烧毁失效。
- 3) 请避免用力拉扯接近开关引出线，以防损坏接近开关的电气连接。
- 4) 禁止覆盖传感器探头表面以避免传感器探测范围。
- 5) 请使用附件安装螺母固定传感器的位置，避免使用其他非标准夹持器材对传感器进行固定以保证传感器良好的灵敏度。
- 6) 传感器使用时应避免强烈的机械振动，工作环境不应该有强烈的电磁干扰以及快速的空气流通。
- 7) 请不要私自拆开传感器，如传感器不能正常工作，请及时与售后联系解决，私自拆开导致的一切后果本公司概不承担。