

Product Description:

- Compact body, meeting the demand for compact space in industries such as electronics and semiconductors, with fixed distance detection.
- BGS products have excellent black and white attenuation characteristics and can be used for detecting non bright flat objects.

Product features:

- Point light source design, small angle scattered light
- $\phi 2\text{mm}$ mounting hole, built-in metal parts, sturdy, long-lasting
- Protection level IP67



| Type | Distance | Beam | Output | Connection | Wiring |
|---------------------------|----------|------------|--------|------------|--------|
| OS4-S6 *M ¹⁾ | 1m | Red | ---- | Cable | Fig.1 |
| OS4-SS6 *M ¹⁾ | 1m | Point lamp | ---- | Cable | Fig.1 |
| OS4-ELN6 *M ¹⁾ | 1m | ---- | NPN | Cable | Fig.2 |
| OS4-EDN6 *M ¹⁾ | 1m | ---- | NPN | Cable | Fig.3 |
| OS4-ELP6 *M ¹⁾ | 1m | ---- | PNP | Cable | Fig.4 |
| OS4-EDP6 *M ¹⁾ | 1m | ---- | PNP | Cable | Fig.5 |

Note 1): * M refers to the cable length in meters. If there is no * M in the model, the default cable length is 2 meters.

TECHNICAL SPECIFICATION

| | | | |
|------------------------------|-----------------------------------|--------------------------------------|--|
| OPERATING VOLTAGE | 10...30 V DC Class2 | AMBIENT TEMPERATURE OPERATION | -10°C...+55°C |
| RIPPLE VOLTAGE | $\pm 10\%$ of U_B | AMBIENT TEMPERATURE STORAGE | -40°C...+70°C |
| LIGHT SOURCE TYPE | RED LED 630nm Point lamp 630nm | UL TEMPERATURE | 50°C |
| OUTPUT CHARACTERISTIC | PNP/NPN | CIRCUIT PROTECTION | Short-circuit protection, reverse polarity protection, over-load protection |
| LOAD CURRENT | $\leq 50\text{mA}$ | PROTECTION DEGREE | IP67 |
| SWITCHING FREQUENCY | 800Hz | HOUSING MATERIAL | PC+PBT |
| | | CONNECTING TYPE | *m PVC cable |

DIMENSIONS

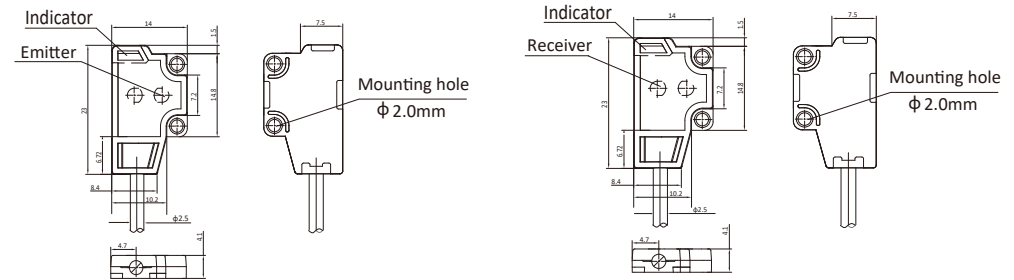

Install

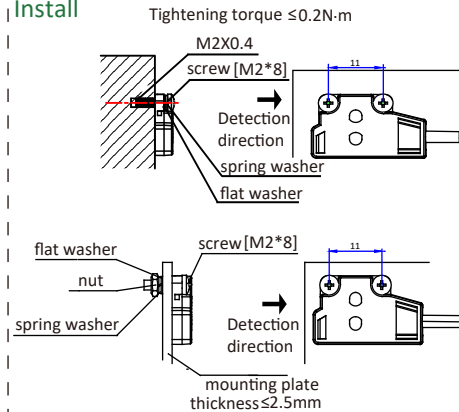

INDICATORS

| | |
|------------------------|--------|
| steady state indicator | Green |
| Output indicator | Yellow |

SAFETY PRECAUTIONS

| | |
|--------------------|---|
| ⚠ DANGEROUS | This product is for the purpose of object detection only. Do not use this product for the purpose of protecting human body or human body parts. This product should not be used as an explosion-proof product. Do not use this product in dangerous places or in the environment of potentially explosive gases. Failure to use the control or adjustment device or perform the steps in accordance with this regulation may result in harmful radiation exposure. |
| ⚠ WARN | Ce produit est à des fins de détection d'objets seulement. N'utilisez pas ce produit dans le but de protéger le corps humain ou des parties du corps humain. Ce produit ne doit pas être utilisé comme produit antidéflagrant. Ne pas utiliser ce produit dans des endroits dangereux ou dans l'environnement de gaz potentiellement explosifs. La non-utilisation du dispositif de commande ou de réglage ou l'exécution de certaines étapes conformément au présent règlement peut entraîner une exposition aux rayonnements nocifs. |
| NOTICE | This product is a sensor with DC power supply. Please do not apply AC power supply. If AC voltage applied, the product may explode or catch fire. Ce produit est un capteur avec alimentation cc. Veuillez ne pas appliquer d'alimentation en courant alternatif. En cas de tension, le produit peut exploser ou prendre feu. |
| | Do not use the same wiring with the power cord and high-voltage line, otherwise the main module may fail or be damaged due to noise. When using a commercially available switching regulator, be sure to ground the housing ground terminal and the ground terminal. Please do not use this product outdoors. N'utilisez pas le même câblage avec le cordon d'alimentation et la ligne à haute tension, sinon le module principal peut tomber en panne ou être endommagé en raison du bruit. Lorsque vous utilisez un régulateur de commutation disponible dans le commerce, assurez-vous de mettre à la terre le terminal d'habitation et le terminal de terre. Veuillez ne pas utiliser ce produit à l'extérieur. |

Maintain

Disassemble; please return to ELCO

ELECTRICAL CONNECTION

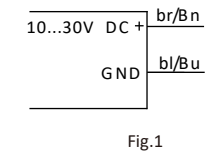

Fig.1

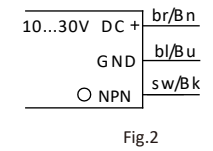

Fig.2

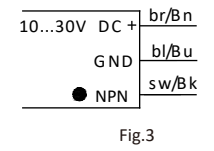

Fig.3

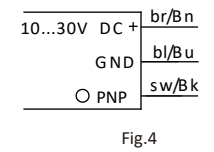

Fig.4

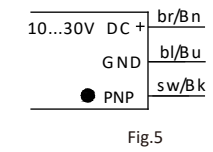

Fig.5

○ =Light on
● =Dark on

产品说明:

- 小巧机身，满足电子，半导体等行业对紧凑空间的需求，定距离检测。
- BGS产品具有优良的黑白衰减特性，使用与检测非光亮平面物体。

产品特点:

- 点光源设计，小角度发散光
- $\phi 2\text{mm}$ 安装孔，内置金属件，坚固，长寿命
- 防护等级IP67



对射式



| 型号 | 检测距离 | 光源 | 输出方式 | 连接方式 | 接线图 |
|---------------------------|------|------|------|------|-----|
| OS4-S6 *M ¹⁾ | 1m | 红光 | ---- | 线缆 | 图1 |
| OS4-SS6 *M ¹⁾ | 1m | 点光源 | ---- | 线缆 | 图1 |
| OS4-ELN6 *M ¹⁾ | 1m | ---- | NPN | 线缆 | 图2 |
| OS4-EDN6 *M ¹⁾ | 1m | ---- | NPN | 线缆 | 图3 |
| OS4-ELP6 *M ¹⁾ | 1m | ---- | PNP | 线缆 | 图4 |
| OS4-EDP6 *M ¹⁾ | 1m | ---- | PNP | 线缆 | 图5 |

注1): *M表示线缆长度, 单位米, 型号中无*M默认线缆长度为2米。

技术参数

| | | | |
|------|------------------------|------|-------------------------|
| 工作电压 | 10...30V DC Class2 | 工作温度 | -10°C...+55°C |
| 纹波电压 | ±10% of U _a | 环境温度 | -40°C...+70°C |
| 光源 | 红光 630nm 点光源 630nm | UL温度 | 50°C |
| 输出特性 | PNP/NPN | 保护电路 | 短路保护 反极性保护 输出过载保护 |
| 负载电流 | ≤50mA | 防护等级 | IP67 |
| 开关频率 | 800Hz | 外壳 | PC+PBT |
| | | 连接方式 | *m PVC线缆 |

外形尺寸

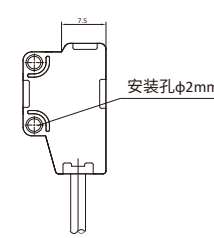
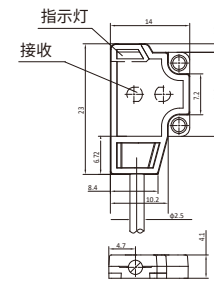
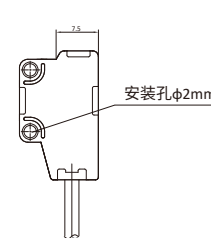
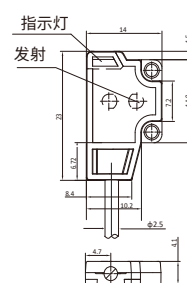

安装

紧固扭矩 ≤ 0.2N m

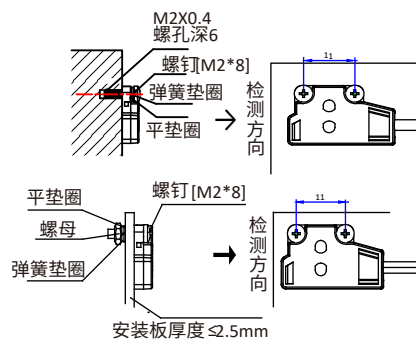

维修

禁止客户拆解产品, 请返厂维修

操作指示

| | |
|-------|----|
| 稳态指示灯 | 绿色 |
| 输出指示灯 | 黄色 |

安全防御措施

| | |
|------------|--|
| ▲危险 | <ul style="list-style-type: none"> • 本产品仅供目标物检测之用, 请勿将本产品用于保护人体或人体部位等目的。 • 本产品不得作为防爆产品使用, 请勿在危险场所或潜在爆炸气体的环境中使用本产品。 • 若不按此规定使用控制或调整装置、或执行各步操作, 就可能引起有害的辐射照射。 |
| ▲警告 | <ul style="list-style-type: none"> • 本产品是采用直流供电的传感器, 请勿施加交流电源, 如果施加交流电压, 则可能导致产品爆炸或起火。 |
| 注意 | <ul style="list-style-type: none"> • 请勿与电源线和高压线使用同一配线, 否则可能因噪声声导致主模块发生故障或受损。 • 使用市面所售的开关稳压器时, 请务必将壳体接地端子与接地端子接地。 • 请勿在室外使用本产品。 |

接线图



图1



图2

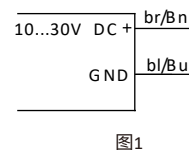

图3

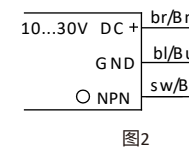

图4

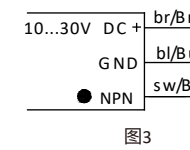
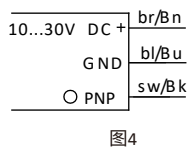
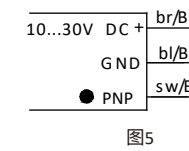

图5

○ =亮通
● =暗通