

OS10S SERIES PHOTOELECTRIC SENSOR



Product Description:

- High performance small square type photoelectric sensor, standard mounting aperture 25.4mm ,100mm diffuse reflection transparent object detection type
- suitable for logistics, photovoltaic, lithium, AGV and other industries

Product features:

- Equipped with red LED light source
- IP67 protection rating

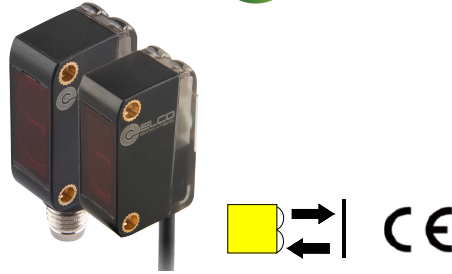

Type	Distance	Beam	Output	Connection	Wiring
OS10S-TK100CN6 *M ¹⁾	100mm	Red LED	NPN	Cable	Fig.1
OS10S-TK100CP6 *M ¹⁾	100mm	Red LED	PNP	Cable	Fig.2
OS10S-TK100CN6Q8	100mm	Red LED	NPN	M8 Connector,4pin	Fig.3
OS10S-TK100CP6Q8	100mm	Red LED	PNP	M8 Connector,4pin	Fig.4
OS10S-TK100CN6Q8.3	100mm	Red LED	NPN	M8 Connector,3pin	Fig.5
OS10S-TK100CP6Q8.3	100mm	Red LED	PNP	M8 Connector,3pin	Fig.6

Note 1): * M refers to the cable length in meters. If there is no * M in the model, the default cable length is 2 meters.

TECHNICAL SPECIFICATION

OPERATING VOLTAGE	10...30VDC Class 2	AMBIENT TEMPERATURE OPERATION	-20°C...+60°C
LIGHT SOURCE TYPE	Red LED	AMBIENT TEMPERATURE STORAGE	-40°C...+70°C
OUTPUT CHARACTERISTIC	PNP/NPN	CIRCUIT PROTECTION	Short-circuit protection, reverse polarity protection, over-load protection
LOAD CURRENT	≤100mA	PROTECTION DEGREE	IP67
SWITCHING FREQUENCY	200Hz	ADJUSTMENT OF OPERATING DISTANCE	Adjust
ADJUSTMENT OF OPERATING DISTANCE	Adjust	PROTECTION DEGREE	IP67
SWITCH MODE	Light On or Dark on	HOUSING MATERIAL	PC+PBT,PMMA
		CONNECTING TYPE	*m PVC cable/M8 connector

SAFETY PRECAUTIONS

▲ DANGEROUS	This product is for the purpose of object detection only.Do not use this product for the purpose of protecting human body or human body parts.This product should not be used as an explosion-proof product.Do not use this product in dangerous places or in the environment of potentially explosive gases. Failure to use the control or adjustment device or perform the steps in accordance with this regulation may result in harmful radiation exposure.
▲ WARN	Ce produit est à des fins de détection d'objets seulement.N'utilisez pas ce produit dans le but de protéger le corps humain ou des parties du corps humain.Ce produit ne doit pas être utilisé comme produit antidéflagrant.Ne pas utiliser ce produit dans des endroits dangereux ou dans l'environnement de gaz potentiellement explosifs. La non-utilisation du dispositif de commande ou de réglage ou l'exécution des étapes conformément au présent règlement peut entraîner une exposition aux rayonnements nocifs.
NOTICE	This product is a sensor with DC power supply.Please do not apply AC power supply.If AC voltage applied,the product may explode or catch fire. Ce produit est un capteur avec alimentation cc.Veuillez ne pas appliquer d'alimentation en courant alternatif.En cas de tension,le produit peut exploser ou prendre feu.
	Do not use the same wiring with the power cord and high-voltage line,otherwise the mainmodule may fail or be damaged due to noise.When using a commercially available switching regulator,be sure to ground the housing/ground terminal and the ground terminal. Please do not use this product outdoors. N'utilisez pas le même câblage avec le cordon d'alimentation et la ligne à haute tension, sinon le module principal peut tomber en panne ou être endommagé en raison du bruit.Lorsque vous utilisez un régulateur de commutation disponible dans le commerce,assurez-vous de mettre à la terre le terminal d'habitation et le terminal de terre.Veuillez ne pas utiliser ce produit à l'extérieur.

MAINTAIN

Disassemble;please return to ELCO

OS10S SERIES PHOTOELECTRIC SENSOR



DIMENSIONS

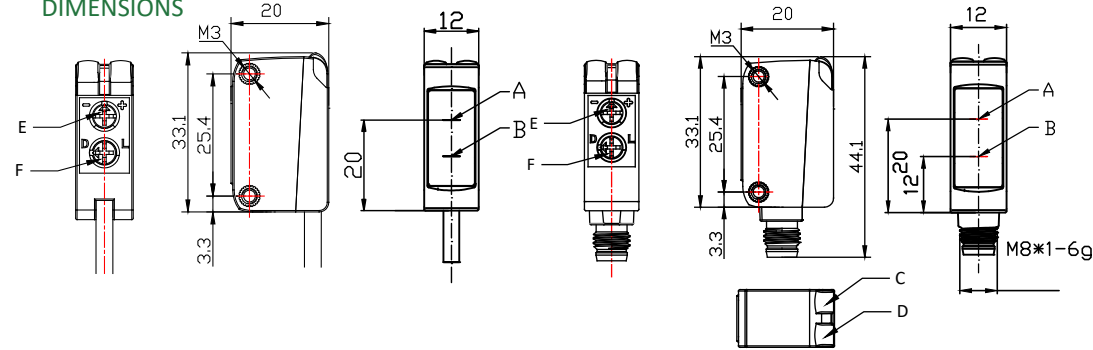

INDICATORS

A	Receiver	
B	Emitter	
C	Output indicator	Yellow
D	steady state indicator	Green
E	Distance adjustment knob	
F	Switch mode	L.O. or D.O.

INSTALL

Recommended to use M3*0.5 screw for fastening
Tightening torques≤0.5N m

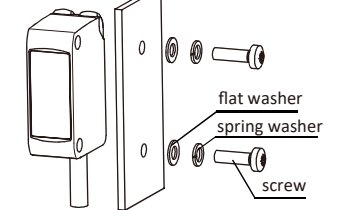

ELECTRICAL CONNECTION

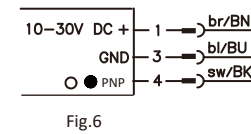
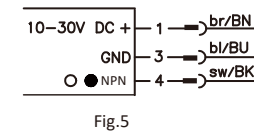
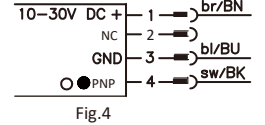
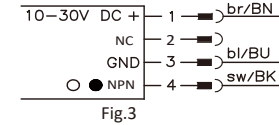
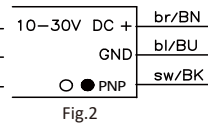
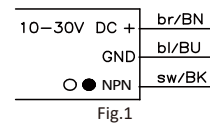

M8 Connector 4pin

M8 Connector 3pin

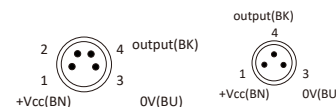

○ =Light on
● =Dark on

产品说明:

- 高性能小方型光电传感器, 标准安装孔径25.4mm, 100mm漫反射透明体检测型
- 适用于物流运输、光伏、锂电、AGV等行业

产品特点:

- 亮暗通、检测距离可调节
- IP67防护等级

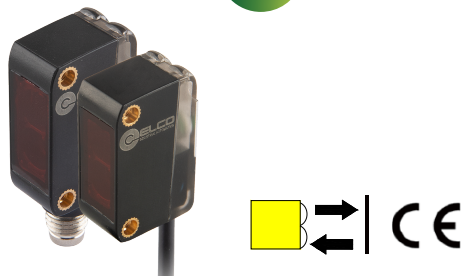

型号	检测距离	光源	输出方式	连接方式	接线图
OS10S-TK100CN6 *M ¹⁾	100mm	红光	NPN	线缆	图1
OS10S-TK100CP6 *M ¹⁾	100mm	红光	PNP	线缆	图2
OS10S-TK100CN6Q8	100mm	红光	NPN	M8 连接器,4pin	图3
OS10S-TK100CP6Q8	100mm	红光	PNP	M8 连接器,4pin	图4
OS10S-TK100CN6Q8.3	100mm	红光	NPN	M8 连接器,3pin	图5
OS10S-TK100CP6Q8.3	100mm	红光	PNP	M8 连接器,3pin	图6

注1): *M表示线缆长度, 单位米, 型号中无*M默认线缆长度为2米。

技术参数

工作电压	10...30VDC Class 2	工作温度	-20°C...+60°C
光源	红光 LED	环境温度	-40°C...+70°C
输出特性	PNP/NPN	保护电路	短路保护、反极性保护 输出过载保护
负载电流	≤100mA	防护等级	IP67
开关频率	200Hz	外壳	PC+PBT, PMMA
检测距离调节	旋钮调节	连接方式	*m PVC线缆/M8 连接器
开关模式设置	亮暗通可选		

安全防护措施

危险	<ul style="list-style-type: none"> ●本产品仅供目标物检测之用, 请勿将本产品用于保护人体或人体部位等目的。 ●本产品不得作为防爆产品使用, 请勿在危险场所或潜在爆炸气体的环境中使用本产品。 ●若不按此规定使用控制或调整装置、或执行各步操作, 就可能引起有害的辐射照射。
警告	<ul style="list-style-type: none"> ●本产品是采用直流供电的传感器, 请勿施加交流电源, 如果施加交流电压, 则可能导致产品爆炸或起火。
注意	<ul style="list-style-type: none"> ●请勿与电源线和高压线使用同一配线, 否则可能因噪音声导致主模块发生故障或受损。 ●使用市面所售的开关稳压器时, 请务必将壳体接地端子和接地端子接地。 ●请勿在室外使用本产品。

维修

禁止客户拆解产品, 请返厂维修

外形尺寸

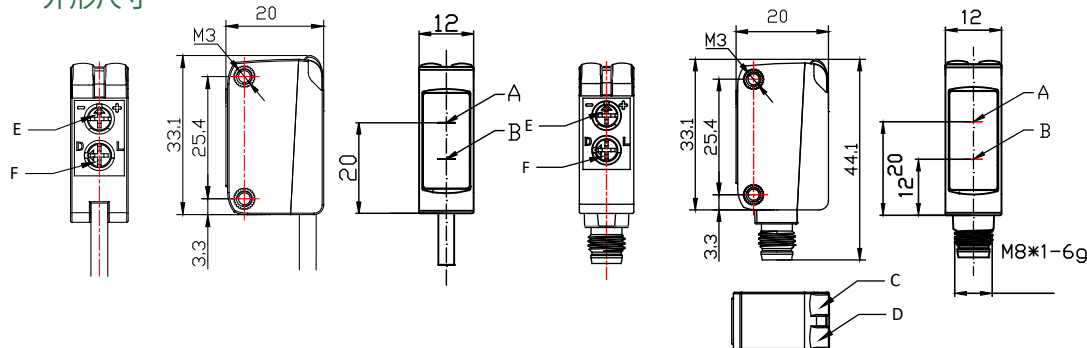

操作指示

A	接收端	
B	发射端	
C	输出指示灯	黄色
D	稳态指示灯	绿色
E	距离调节旋钮	
F	亮暗通旋钮	L亮通/D暗通

安装

建议使用M3*0.5螺钉紧固, 拧紧力矩≤0.5N.m

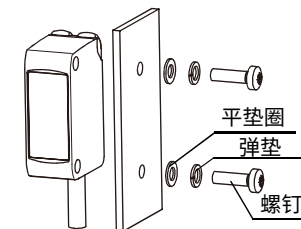

接线图

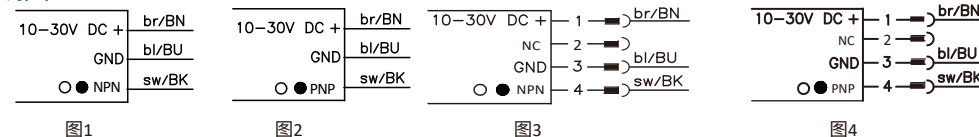

M8连接器 4pin M8连接器 3pin

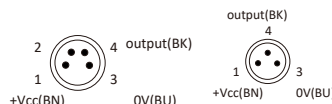

○ =亮通
● =暗通