

Product Description:

- High performance small square type photoelectric sensor, standard mounting aperture 25.4mm , Infrared laser 1m TOF type BGS diffuse reflection
- Suitable for logistics, photovoltaic, lithium, AGV and other industries

Product features:

- 1m TOF type diffuse reflection button teaching detection distance,adjustble between light-on and drak-on
- Equipped with red LED light source
- IP67 protection rating

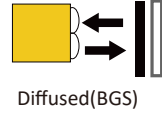
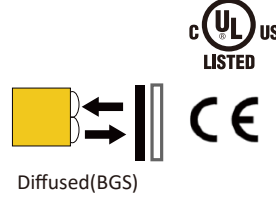

Type	Distance	Detection light source	Indicated light source	Output	Connection	Wiring
OS10S-AK1000CN6 *M <sup>1)</sup>	50mm-1000mm	Infrared VCSEL	Red LED	NPN	Cable	Fig.1
OS10S-AK1000CP6 *M <sup>1)</sup>	50mm-1000mm	Infrared VCSEL	Red LED	PNP	Cable	Fig.2

Note 1): \* M refers to the cable length in meters. If there is no \* M in the model, the default cable length is 2 meters.

TECHNICAL SPECIFICATION

OPERATING VOLTAGE	10...30 V DC Class 2	AMBIENT TEMPERATURE OPERATION	-20°C...+60°C
LIGHT SOURCE TYPE	Infrared VCSEL 940nm	AMBIENT TEMPERATURE STORAGE	-40°C...+70°C
OUTPUT CHARACTERISTIC	PNP/NPN	UL TEMPERATURE	50°C
LOAD CURRENT	≤100mA	CIRCUIT PROTECTION	Short-circuit protection, Reverse polarity protection, Over-load protection
OPERATING FREQUENCY	30Hz	PROTECTION DEGREE	IP67
ADJUSTMENT OF OPERATING DISTANCE	Button Settings	HOUSING MATERIAL	PC+PBT,PMMA
DETECITON LIGHT SPOT SIZE@1M	40mm*20mm	CONNECTING TYPE	PVC cable
		INDICATED LIGHT SOURCE	Red LED

SAFETY PRECAUTIONS

<b>⚠ DANGEROUS</b>	This product is for the purpose of object detection only,Do not use this product for the purpose of protecting human body or human body parts.This product should not be used as an explosion-proof product.Do not use this product in dangerous places or in the environment of potentially explosive gases. Failure to use the control or adjustment device or perform the steps in accordance with this regulation may result in harmful radiation exposure.
<b>⚠ WARN</b>	Ce produit est à des fins de détection d' objets seulement.N' utilisez pas ce produit dans le but de protéger le corps humain ou des parties du corps humain.Ce produit ne doit pas être utilisé comme produit antidéflagrant.Ne pas utiliser ce produit dans des endroits dangereux ou dans l' environnement de gaz potentiellement explosifs. La non-utilisation du dispositif de commande ou de réglage ou l' exécution des étapes conformément au présent règlement peut entrainer une exposition aux rayonnements nocifs.
<b>NOTICE</b>	This product is a sensor with DC power supply.Please do not apply AC power supply.If AC voltage applied,the product may explode or catch fire. Ce produit est un capteur avec alimentation cc.Veuillez ne pas appliquer d' alimentation en courant alternatif.En cas de tension le produit peut exploser ou prendre feu. Do not use the same wiring with the power cord and high-voltage line.otherwise the main module may fail or be damaged due to noise.When using a commercially available switching regulator,be sure to ground the housing/ground terminal and the ground terminal. Please do not use this product outdoors. N'utilisez pas le même câblage avec le cordon d'alimentation et la ligne à haute tension,sinon le module principal peut tomber en panne ou être endommagé en raison du bruit.Lorsque vous utilisez un régulateur de commutation disponible dans le commerce,assurez-vous de mettre à la terre le terminal d'habitation et le terminal de terre.Veuillez ne pas utiliser ce produit à l'extérieur.

Maintain Disassemble;please return to Elco  
Laser lable Pasting on packing bag

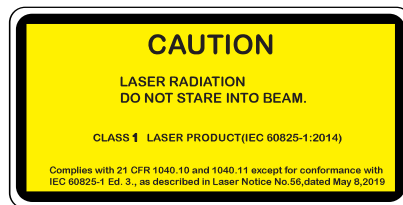

DIMENSIONS

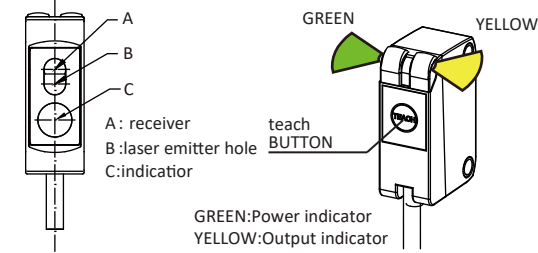
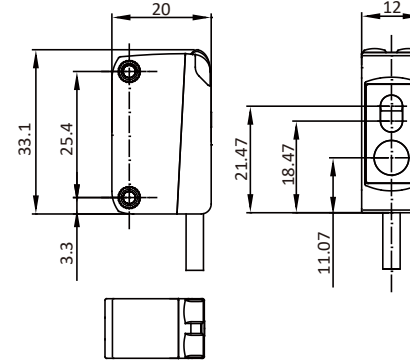

ELECTRICAL CONNECTION

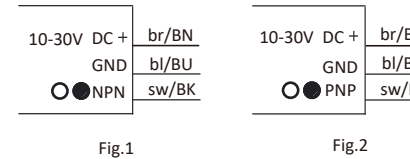

- = Light output
- = Dark output

INSTALL

Recommended to use M3\*0.5 screw for fastening  
Tightening torque≤0.5N.m

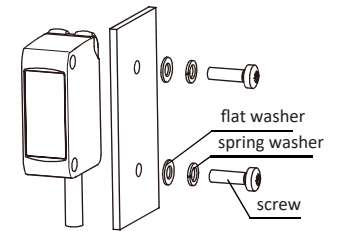

OS10S SERIES PRODUCT INSTRUCTIONS:

1. Single point mode setting: press and hold the key for more than 3 seconds and less than 8 seconds the green light flashes 3 times. The setting is successful.The adjustable range is 100mm-1000mm.
2. Window mode setting: place the target at the required nearest sensing distance as the nearest threshold (≥ 70mm), Short press the key (more than 200ms, less than 2S) and the yellow light flashes; Place the target at the required farthest distance as the farthest threshold (≤ 1000mm), Short press the key, the green light flashes three times, and the setting is successful; Set the maximum distance and complete the operation within 10s, otherwise yellow light and green flashing alternately and exits automatically.
3. Light to dark switching setting: Long press the button more than 8 seconds the green light flashes 3 times to switch the current light to dark switching state.The alternating flashing of yellow and green lights indicates a failed setting.
4. There should be no fingerprints and stains on the surface of the window.It should be cleaned,otherwise it will affect the performance of the product.
- 5.The product cannot be used with ordinary transparent glass or acrylic sheets.And the product will be sensitive to the above objects.

SINGLE POINT MODE

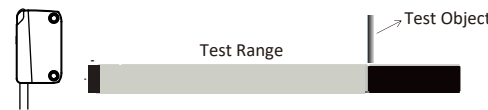

WINDOW MODE

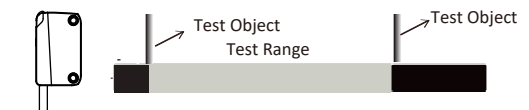

## 产品说明:

- 高性能小型光电传感器,标准安装孔径25.4mm,红外激光1m的TOF型BGS漫反射
- 适用于物流输送、光伏、锂电、AGV等行业

## 产品特点:

- 1m TOF型漫反射按键检测距离,亮暗通可调
- 可提供红光指示光源
- IP67防护等级

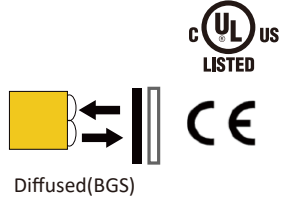

型号	检测距离	检测光源	指示光源	输出方式	连接方式	接线图
OS10S-AK1000CN6 *M <sup>1)</sup>	50mm...1000mm	红外VCSEL	红光LED	NPN	线缆	图1
OS10S-AK1000CP6 *M <sup>1)</sup>	50mm...1000mm	红外VCSEL	红光LED	PNP	线缆	图2

注1): \*M表示线缆长度,单位米,型号中无\*M默认线缆长度为2米。

## 技术参数

工作电压	10...30 V DC Class 2	工作温度	-20°C...+60°C
光源	红外VCSEL 940nm	环境温度	-40°C...+70°C
输出特性	PNP/NPN	UL 温度	50°C
负载电流	≤100mA	保护电路	短路保护、反极性保护 输出过载保护
开关频率	30Hz	防护等级	IP67
检测距离设定	按键设定	外壳	PC+PBT,PMMA
1米处检测光斑尺寸	40mm*20mm	连接方式	PVC线缆
指示光源	红光LED		

## 安全防护措施

▲危险	<ul style="list-style-type: none"> <li>●本产品仅供目标物检测之用,请勿将本产品用于保护人体或人体部位等目的。</li> <li>●本产品不得作为防爆产品使用,请勿在危险场所或潜在爆炸气体的环境中使用本产品。</li> <li>●若不按此规定使用控制或调整装置、或执行各步操作,就可能引起有害的辐射照射。</li> </ul>
▲警告	<ul style="list-style-type: none"> <li>●本产品是采用直流供电的传感器,请勿施加交流电源,如果施加交流电压,则可能导致产品爆炸或起火。</li> </ul>
注意	<ul style="list-style-type: none"> <li>●请勿与电源线和高压线使用同一配线,否则可能因噪音声导致主模块发生故障或受损。</li> <li>●使用市面所售的开关稳压器时,请务必将壳体接地端子和接地端子接地。</li> <li>●请勿在室外使用本产品。</li> </ul>

## 维修

禁止客户拆解产品,请返厂维修

## 激光标识

放入包装袋中

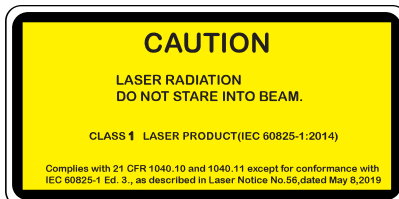

## 外形尺寸

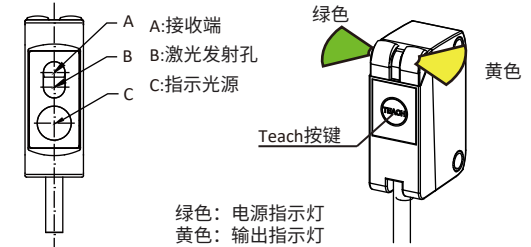
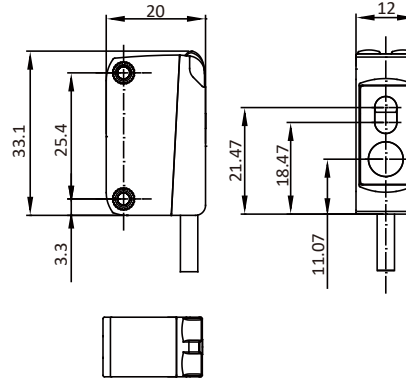

## 接线图



图1

图2

○ = 亮通  
● = 暗通

## 安装

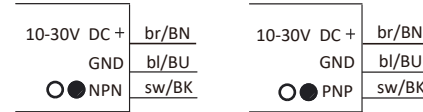
建议使用M3\*0.5螺钉紧固,拧紧力矩≤0.5N.m

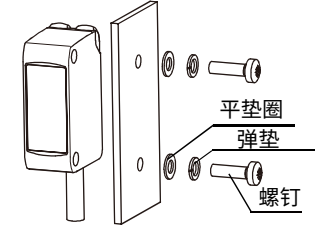

## OS10S系列产品使用说明

- 1.单点模式设置:长按按键3秒以上,8秒以下 绿灯闪烁3次,设置成功。可设置范围为100mm-1000mm。
- 2.窗口模式设置:将目标放置到要求最近的感应距离作为最近阈值(≥70mm),短按按键(200ms以上,3s以下)黄灯闪烁;将目标放置到要求的最远距离作为最远阈值(≤1000mm),短按按键,绿灯闪烁三下,设置成功;设置最远距离需在10s内完成操作,否则黄绿灯交替闪烁交替闪烁后自动退出。
- 3.亮暗通切换:长按按键8秒以上,绿灯闪烁3次,设置成功。黄绿灯交替闪烁表示设置失败。
- 4.产品不可透过普通透明玻璃或亚克力板使用,产品会对上述物体有感应。
- 5.视窗表面不可有脏污,需清洁干净,否则影响产品性能。

## 单点模式:



## 窗口模式:

