

Product Description:

- M18 cylindrical installation method, high cost-effectiveness, and a wide selection of models.
- Suitable for applications in logistics transportation, textile, garage, and electronics industries.



Product features:

- Universal installation method
- Bright status indicator light

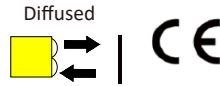

Type	Distance	Beam	Output	Connection	Wiring
OP18-TK100VP6 *M ¹⁾	100mm	Infrared light	PNP	Cable	Fig.1
OP18-TK100VP6Q	100mm	Infrared light	PNP	M12 Connector	Fig.2
OP18-TK100VN6 *M ¹⁾	100mm	Infrared light	NPN	Cable	Fig.3
OP18-TK100VN6Q	100mm	Infrared light	NPN	M12 Connector	Fig.4

Note 1): * M refers to the cable length in meters. If there is no * M in the model, the default cable length is 2 meters.

TECHNICAL SPECIFICATION

OPERATING VOLTAGE	10...30 V DC	AMBIENT TEMPERATURE OPERATION	-25°C...+65°C
RIPPLE VOLTAGE	±10% of U _B	AMBIENT TEMPERATURE STORAGE	-40°C...+70°C
LIGHT SOURCE TYPE	Infrared light	CIRCUIT PROTECTION	Short-circuit protection, reverse polarity protection, over-load protection
OUTPUT CHARACTERISTIC	PNP/NPN	PROTECTION DEGREE	IP67
LOAD CURRENT	≤100mA	HOUSING MATERIAL	PBT+PC
SWITCHING FREQUENCY	100Hz	CONNECTING TYPE	*m PVC cable /M12 connector
ADJUSTMENT OF SENSITIVITY	Knob adjustment		

DIMENSIONS

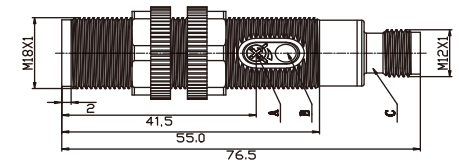
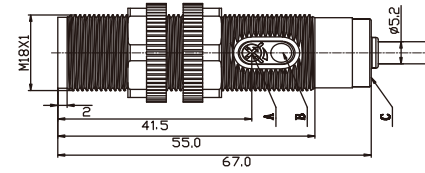

EOM18-1(Mounting accessories)

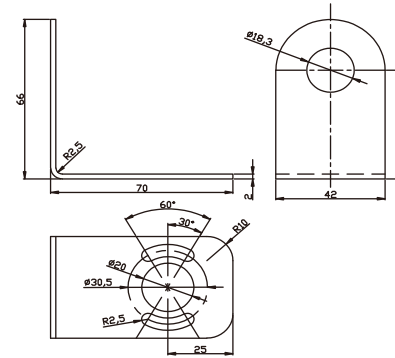

INDICATORS

A	Sensitivity adjustment	
B	Steady state indicator	LED/Green
C	Output indicator	LED/Yellow

ELECTRICAL CONNECTION

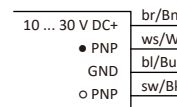

Fig. 1

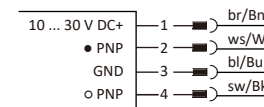

Fig. 2

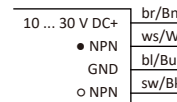

Fig. 3

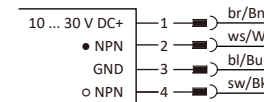
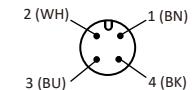

Fig. 4



○ = Light on
● = Dark on

产品说明:

- M18圆柱形安装方式, 高性价比, 丰富的机型选择。
- 适用物流运输, 纺织, 车库, 电子行业应用。



产品特点:

- 通用安装方式
- 明亮状态指示灯



型号	检测距离	光源	输出方式	连接方式	接线图
OP18-TK100VP6 *M ¹⁾	100mm	红外光	PNP	线缆	图1
OP18-TK100VP6Q	100mm	红外光	PNP	M12连接器	图2
OP18-TK100VN6 *M ¹⁾	100mm	红外光	NPN	线缆	图3
OP18-TK100VP6Q	100mm	红外光	NPN	M12连接器	图4

注1): *M表示线缆长度, 单位米, 型号中无*M默认线缆长度为2米。

技术参数

工作电压	10 ... 30 V DC	工作温度	-25°C...+65°C
纹波电压	±10% of U _B	环境温度	-40°C...+70°C
光源	红外光	保护电路	短路保护 反极性保护 输出过载保护
输出特性	PNP/NPN	防护等级	IP67
负载电流	≤ 100mA	外壳	PBT+PC
开关频率	100Hz	连接方式	*m PVC 线缆 /M12连接器
灵敏度调节	旋钮调节		

外形尺寸

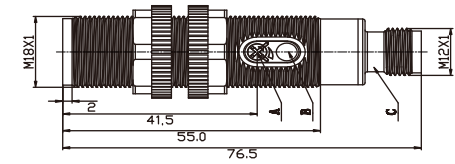
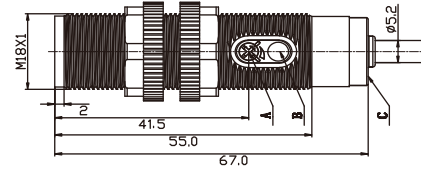

EOM18-1(安装配件)

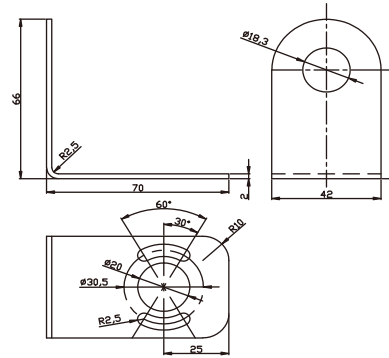

操作指示

A	灵敏度调节	
B	稳态指示灯	LED/绿色
C	输出指示灯	LED/黄色

接线图



图1



图2

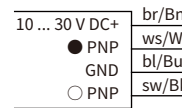

图3

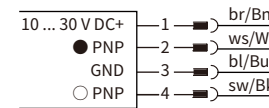

图4

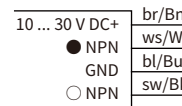
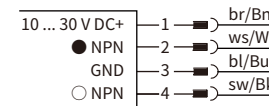
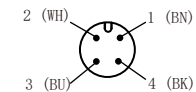

○ = 亮通
● = 暗通