

Product Description:

- M18 cylindrical installation method, metal shell.
- Suitable for logistics transportation, food and beverage, printing, small equipment and other applications.

Product features:

- Strong impact resistance
- 60 meter laser beam

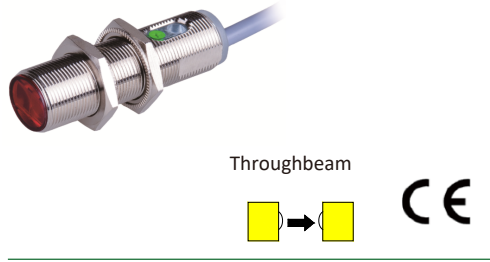

Type	Distance	Beam	Output	Connection	Wiring
OM18-SL606 *M ¹⁾	60m	laser	-----	Cable	Fig.1
OM18-SL606Q	60m	laser	-----	Connector	Fig.2
OM18-EL60VP6 *M ¹⁾	60m	-----	PNP	Cable	Fig.3
OM18-EL60VP6Q	60m	-----	PNP	Connector	Fig.4
OM18-EL60VN6 *M ¹⁾	60m	-----	NPN	Cable	Fig.5
OM18-EL60VN6Q	60m	-----	NPN	Connector	Fig.6

Note 1): * M refers to the cable length in meters. If there is no * M in the model, the default cable length is 2 meters.

TECHNICAL SPECIFICATION

OPERATING VOLTAGE	10...30VDC	AMBIENT TEMPERATURE OPERATION	-25°C...+60°C
RIPPLE VOLTAGE	±10% of U _B	AMBIENT TEMPERATURE STORAGE	-40°C...+70°C
LIGHT SOURCE TYPE	laser	CIRCUIT PROTECTION	Short-circuit protection, reverse polarity protection, over-load protection
OUTPUT CHARACTERISTIC	PNP/NPN	PROTECTION DEGREE	IP67
LOAD CURRENT	≤100mA	HOUSING MATERIAL	Brass
SWITCHING FREQUENCY	800Hz	CONNECTING TYPE	*m PVC cable /M12 connector
ADJUSTMENT OF SENSITIVITY	Knob adjustment		

DIMENSIONS

Emitter

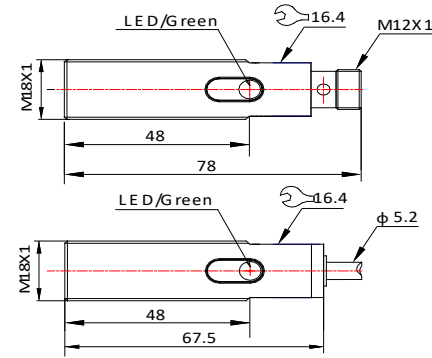

Receiver

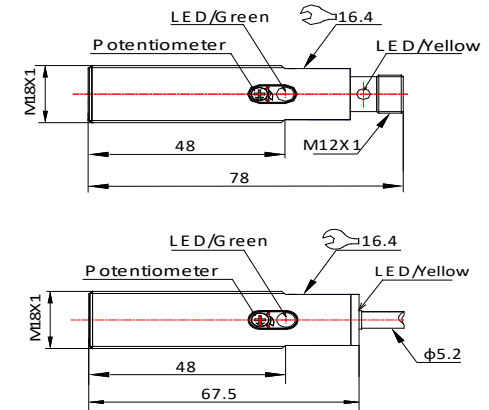

INDICATORS

A	Sensitivity adjustment knob	
B	steady state indicator	Green
C	Output indicator	Yellow

ELECTRICAL CONNECTION

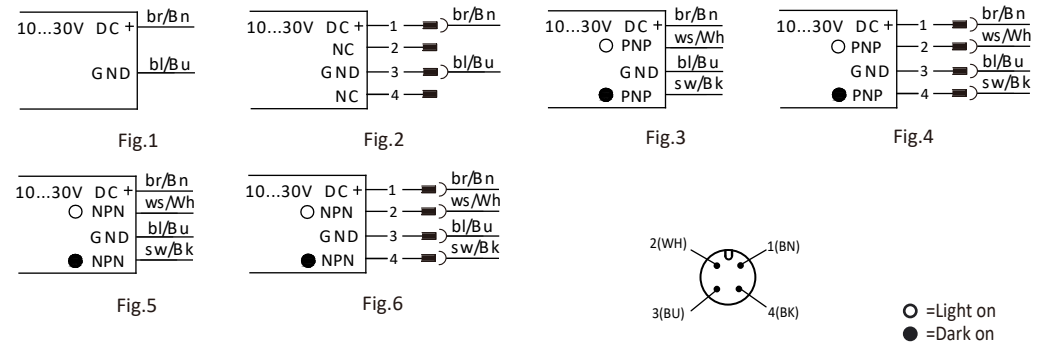

产品说明:

- M18圆柱形安装方式, 金属外壳。
- 适用物流运输, 食品饮料, 印刷, 小型设备等应用。



产品特点:

- 抗冲击能力强
- 60米激光对射

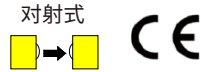

型号	检测距离	光源	输出方式	连接方式	接线图
OM18-SL606 *M ¹⁾	60m	激光	-----	线缆	图1
OM18-SL606Q	60m	激光	-----	M12 连接器	图2
OM18-EL60VP6 *M ¹⁾	60m	-----	PNP	线缆	图3
OM18-EL60VP6Q	60m	-----	PNP	M12 连接器	图4
OM18-EL60VN6 *M ¹⁾	60m	-----	NPN	线缆	图5
OM18-EL60VN6Q	60m	-----	NPN	M12 连接器	图6

注1): *M表示线缆长度, 单位米, 型号中无*M默认线缆长度为2米。

技术参数

工作电压	10...30VDC	工作温度	-25°C...+60°C
纹波电压	±10% of U _I	环境温度	-40°C...+70°C
光源	激光	保护电路	短路保护 反极性保护 输出过载保护
输出特性	PNP/NPN	防护等级	IP67
负载电流	≤100mA	外壳	铜镀镍
开关频率	800Hz	连接方式	*m PVC线缆 /M12连接器
灵敏度调节	旋钮调节		

外形尺寸

发射

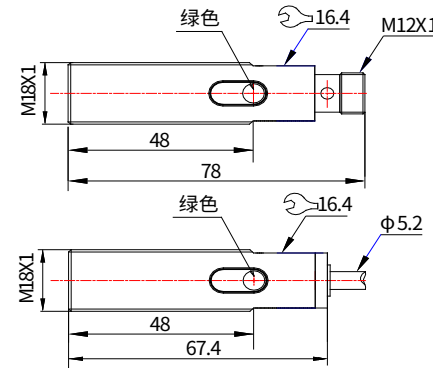

接收

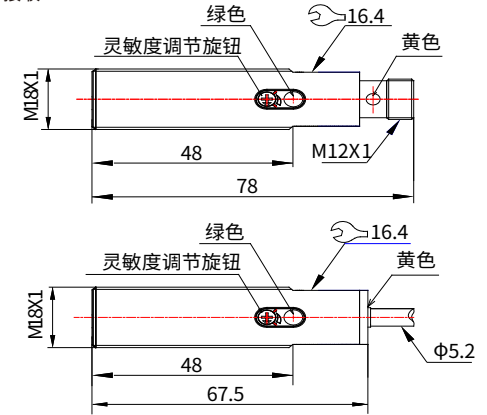

操作指示

A	灵敏度调节	
B	稳态指示灯	绿色
C	输出指示灯	黄色

接线图

