

IO-Link Hub

LKHA-xxxx-M8 (8-bit PNP)

---Installation Manual



1.1 Scope of this manual:

This manual applies to the ELCO IO-Link signal Hub (8-bit M8, 2 types):

LKHA-0800P-M8, LKHA-08UP-M8.

These 2 types of IO-Link hub use identical housings, with identical overall dimensions and connector types. There are differences in the signal types supported by different types of products. The coding rules are as follows:

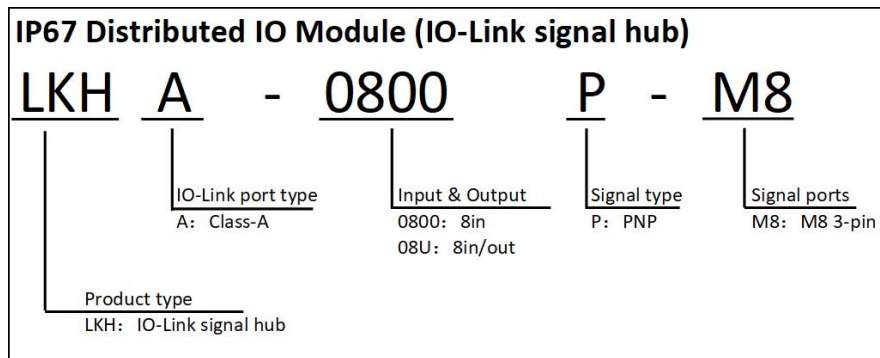

Product overview:

1) LKHA-0800P-M8

Supply Voltage 24VDC, self-consumption max.100mA;

8 x Port module for

8 x Digital Input (Input Supply 8 x 24VDC/200mA)

2) LKHA-08UP-M8

Supply Voltage 24VDC, self-consumption max.100mA;

8 x Port module for

8 x Digital Input (Input Supply 8 x 24VDC/200mA)

or

8 x Digital Output (8 x 24VDC/500mA, max. in total 2A)

You can see the datasheet of 2 types in Section 2.1.

This product is specifically designed for industrial use and needs to be applied under specific conditions. This product serves as an IO-Link device and needs to be connected to the IO-Link master for use.

1.2 Basic knowledge requirements

Operators need to have basic knowledge in the fields of electrical and automation engineering. Any improper operation may cause harm to the equipment or human body.

This manual describes each component based on valid data at the time of release, and new components and parameter adjustments will be updated in the new version of the manual.

1.3 Guide:

This manual describes the hardware of IO-Link signal Hub.

Covered topics are:

- Installation and wiring
- Commissioning and diagnostics
- Components
- Article numbers
- Technical specifications

1.4 Technical support:

Please contact your local ELCO representative or call hotline if you have any questions about the products described in this manual.

Additional information about ELCO products is available:

Corporate name: Tianjin Elco Automation Co., Ltd

Company address: No. 12, 4th XEDA Branch Road, Xiqing Economic-Technological Development Area ,Tianjin China

Website: <https://www.elcoautomation.com/en-us/>

TEL: +86 22 23888288

1.5 Electrical installation:



WARNING

Danger due to electrical voltage!

An unqualified installation can affect the use of the equipment or lead to equipment damage!

- Only qualified electrical engineering personnel may install the modules.
- Only operate on 24 V DC voltage.
- Must be connected to limited power source (LPS).
- Use Copper Conductors Only. Use min. 22 AWG for IO-Link port connector and min. 26 AWG for Signal I/O connector.

ATTENTION

La tension pose un danger!

Une installation non conforme peut affecter l'utilisation de l'appareil ou causer des dommages à l'appareil!

- Seuls les ingénieurs électriciens qualifiés peuvent installer les modules.
- Fonctionne uniquement à 24 V DC.
- Doit être connecté à une alimentation électrique limitée (LPS).
- Utilisez uniquement des conducteurs en cuivre. Le connecteur de port io - LINK utilise un minimum de 22 AWG et le connecteur d'E / s de signal un minimum de 26 AWG.



ATTENTION

Damages due to open plugs and sockets!

Enclosure rating Type 1 is only guaranteed if all connections are tightly sealed.

- Seal unused plugs and sockets with screw plugs or caps.

1.6 Disclaimer of liability:



- Only qualified personnel may perform installation, commissioning, modification, inspection and retrofitting activities.
- Follow the applicable regulations and standards in the operating instructions and manual.
- Follow the safety regulations of the Employers' Liability Insurance Association and electrical engineering.

If the equipment is used in a manner not specified by the manufacturer, the protection provided by the equipment may be impaired. We assume no liability for product damage or subsequent damage arising from non-observance of the regulations or improper handling of the products.

2.1 Datasheet

LKHA-08UP-M8

ARTICLE PROPERTIES

PRODUCT TYPE	IO-Link IP67 hub
DESCRIPTION	8DI / DO, Class-A, 8*M8

ELECTRICAL CONNECTION

IO-LINK	Class-A: 1 × M12 A-code 4-pin, Male	SIGNAL	8 × M8 3 pin, Female
POWER SUPPLY	Included in IO-Link interface		

ELECTRICAL PARAMETERS

INPUT CHANNELS	Max. 8	OUTPUT CHANNELS	Max. 8
INPUT SUPPLY CURRENT	Max. 200 mA per channel, sum 1.6 A	OUTPUT CURRENT	Max. 500 mA per channel, sum 2 A
INPUT TYPE	PNP sensors, mechanical switches, dry contacts, etc.	OUTPUT TYPE	Lamps, solenoidvalve, etc.
INPUT DELAY	1.6 ms	OUTPUT FREQUENCY	Resistive load 100 Hz, Inductive load 5 Hz
MODULE COMMUNICATION INDICATOR	Green LED	PROCESS DATA IN	1 bytes
POWER SUPPLY INDICATOR	Green LED	PROCESS DATA OUT	1 bytes
SIGNAL STATUS INDICATOR	Green LED		

DIAGNOSTICS

COMMUNICATION STATUS	LED indication, communication message	SHORT-CIRCUIT	Support, LED indication
VOLTAGE DETECTION	Support, low voltage alarm	OVERLOAD	Support, LED indication

FUNCTIONAL SAFETY

MTTF (40 °C)	64a
---------------------	-----

GENERAL DATA

PROTECTION CLASS	IP67	OPERATING TEMPERATURE	-25 ... +70 °C
DIMENSIONS	30 × 130 × 31.3 mm	STORAGE TEMPERATURE	-40 ... +85 °C
WEIGHT	117.3 g		

LKHA-0800P-M8

ARTICLE PROPERTIES

PRODUCT TYPE	IO-Link IP67 hub
DESCRIPTION	8DI, Class-A, 8*M8

ELECTRICAL CONNECTION

IO-LINK	Class-A: 1 × M12 A-code 4-pin, Male	SIGNAL	8 × M8 3 pin, Female
POWER SUPPLY	Included in IO-Link interface		

ELECTRICAL PARAMETERS

INPUT CHANNELS	8	OUTPUT CHANNELS	-
INPUT SUPPLY CURRENT	Max. 200 mA per channel, sum 1.6 A	OUTPUT CURRENT	Max. 500 mA per channel, sum 2 A
INPUT TYPE	PNP sensors, mechanical switches, dry contacts, etc.	OUTPUT TYPE	Lamps, solenoidvalve, etc.
INPUT DELAY	1.6 ms	OUTPUT FREQUENCY	Resistive load 100 Hz, Inductive load 5 Hz
MODULE COMMUNICATION INDICATOR	Green LED	PROCESS DATA IN	1 bytes
POWER SUPPLY INDICATOR	Green LED	PROCESS DATA OUT	0 bytes
SIGNAL STATUS INDICATOR	Green LED		

DIAGNOSTICS

COMMUNICATION STATUS	LED indication, communication message	SHORT-CIRCUIT	Support, LED indication
VOLTAGE DETECTION	Support, low voltage alarm	OVERLOAD	Support, LED indication

FUNCTIONAL SAFETY

MTTF (40 °C)	72a
---------------------	-----

GENERAL DATA

PROTECTION CLASS	IP67	OPERATING TEMPERATURE	-25 ... +70 °C
DIMENSIONS	30 × 130 × 31.3 mm	STORAGE TEMPERATURE	-40 ... +85 °C
WEIGHT	117.3 g		

*) : Port type can be set to INPUT/OUTPUT by PLC software.

2.2 LED indicator

IO-Link signal hub indicator

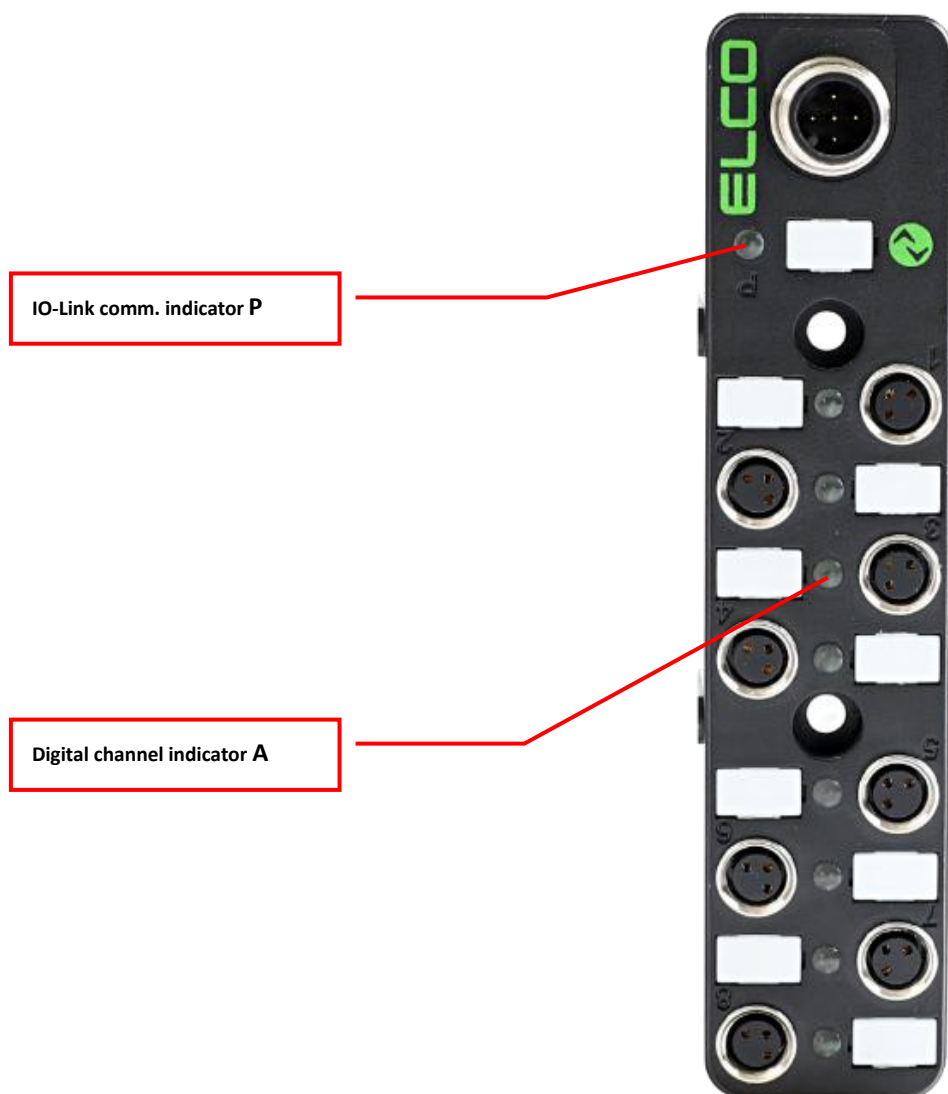

2.3 IO-Link signal hub dimensions

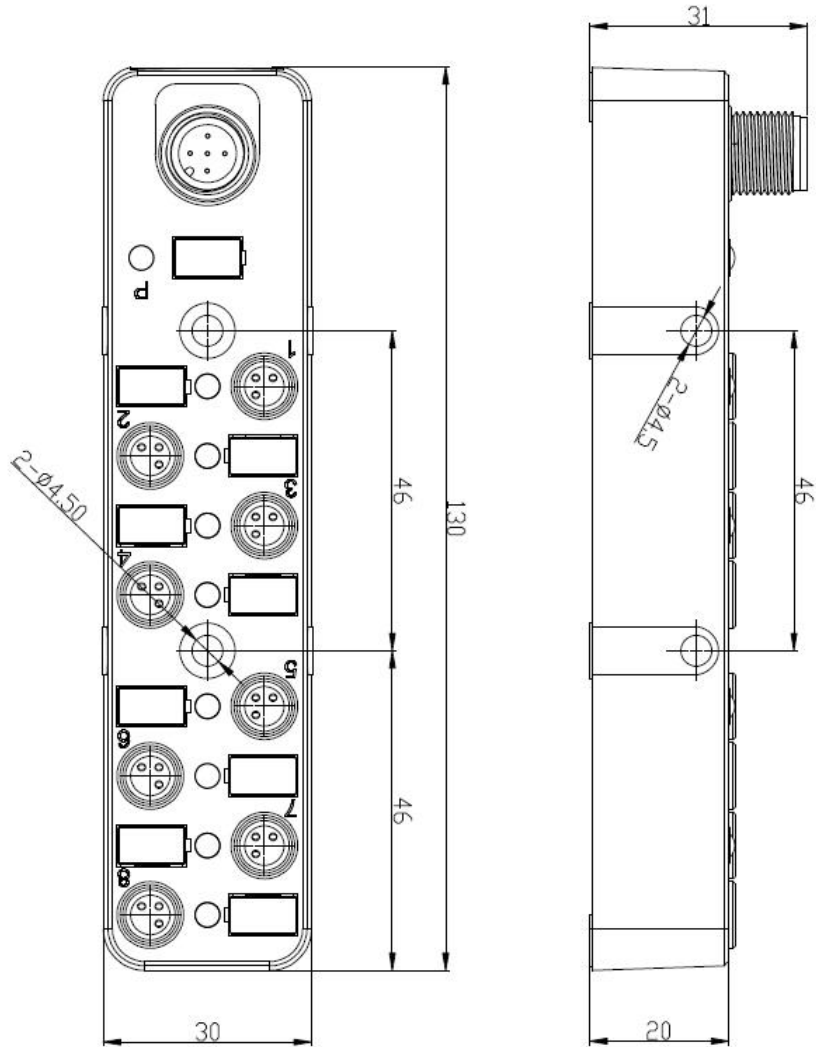

2.4 Mounting the module

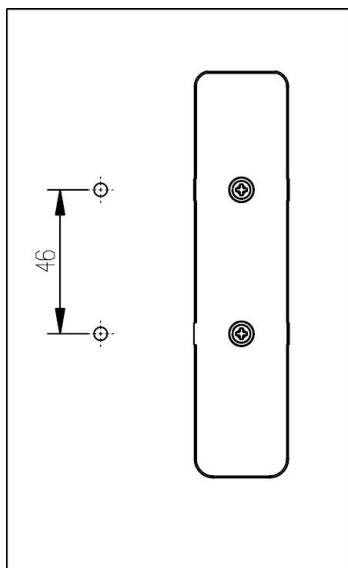

Dimensions in mm

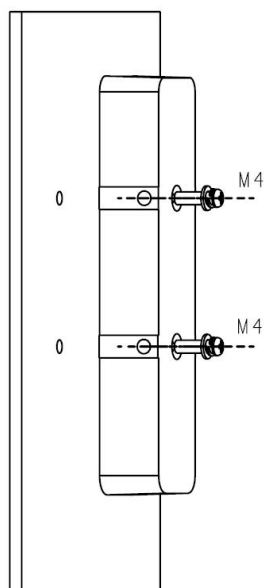

Use screws that are suitable for the mounting surface structure.

2.5 Wiring

Please make sure to cut off power supply when wiring to ensure safety.

- 1) IO-Link port connector (M12 A-Code 4-pin, Male)

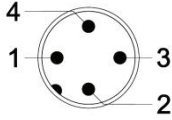

Terminal	Class-A
1	Power supply 24V+ (Us)
2	Power supply P24 (Ua)
3	Power supply GND
4	IO-Link C/Q

- 2) Signal I/O connector (M12 A-Code 5-pin, Female)

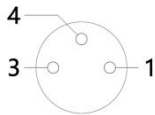

Terminal	M8 connector	
1	Power supply 24V+	
2	-	
3	Power supply GND	
4	Signal input/output A	signal

- 3) Wiring example

- A) Single PNP input signal – 1 connector

connects 1 DI, LKHA-0800P-M8, LKHA-08UP-M8 support this connection.

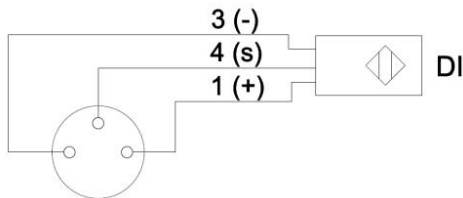

- B) Single PNP output signal – 1 connector connects 1 DO, LKHA-08UP-M8 support this connection.

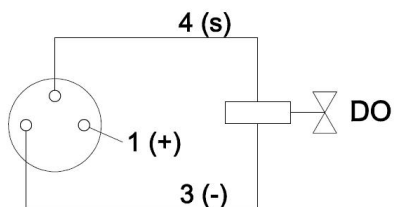

2.6 IO-Link signal hub indicator

Name	Status	Meaning	Fault cause
Module communication Indicator P	Green flash	Receive IO-Link communication	–
	Off	No IO-Link signal received	1.Expansion cable failure 2.Master IO-Link port problem 3.Slave module is damaged
Signal / status Indicator	Red	Abnormal signal	1.Signal overload or short circuit 2.Slave module is damaged
	Green	Have signal	–
	Off	No signal	–