

IO-Link Hub

LKHA-xxxx-Tx (32bit)

----Installation Manual



1.1 Scope of this manual:

This manual applies to the ELCO IO-Link signal Hub (32-bit T, 13 types): LKHA-3200P-TC, LKHA-1616P-TC, LKHA-0032P-TC, LKHA-3200N-TC, LKHA-1616N-TC, LKHA-0032N-TC, LKHA-08UA-TC, LKHA-3200P-TA, LKHA-1616P-TA, LKHA-0032P-TA, LKHA-3200N-TA, LKHA-1616N-TA, LKHA-0032N-TA.

These 13 types of IO-Link hub use identical housings, with identical overall dimensions and connector types. There are differences in the signal types supported by different types of products. The coding rules are as follows:

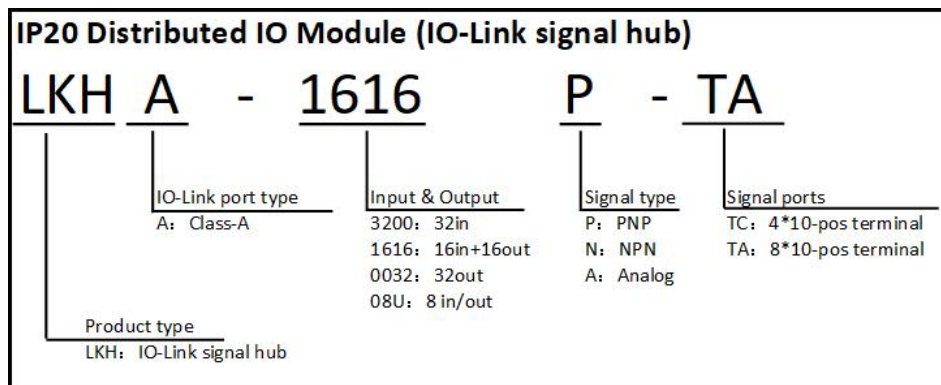

Product overview:

1) LKHA-3200P-TC, LKHA-3200N-TC, LKHA-3200P-TA, LKHA-3200N-TA

Supply Voltage 24VDC, self-consumption max.100mA;

10-pos terminal module for

32 x Digital Input (Input Supply 24VDC/total 4A)

2) LKHA-1616P-TC, LKHA-1616N-TC, LKHA-1616P-TA, LKHA-1616N-TA

Supply Voltage 24VDC, self-consumption max.100mA;

10-pos terminal module for

16 x Digital Input (Input Supply 24VDC/total 2A)

and

16 x Digital Output (16 x 24VDC/500mA, max. in total 6A)

3) LKHA-0032P-TC, LKHA-0032N-TC, LKHA-0032P-TA, LKHA-0032N-TA

Supply Voltage 24VDC, self-consumption max.100mA;

10-pos terminal module for

32 x Digital Output (32 x 24VDC/500mA, max. in total 6A)

4) LKHA-08UA-TC

Supply Voltage 24VDC, self-consumption max.100mA;

10-pos terminal module for

8 x Analog Input (Input Supply 8 x 24VDC/total 2A)

or

8 x Analog Output (8 x 0-10V/0-20mA/4-20mA)

You can see the datasheet of 13 types in Section 2.1.

This product is specifically designed for industrial use and needs to be applied under specific conditions. This product serves as an IO-Link device and needs to be connected to the IO-Link master for use.

1.2 Basic knowledge requirements

Operators need to have basic knowledge in the fields of electrical and automation engineering. Any improper operation may cause harm to the equipment or human body.

This manual describes each component based on valid data at the time of release, and new components and parameter adjustments will be updated in the new version of the manual.

1.3 Guide:

This manual describes the hardware of IO-Link Signal Hub.

Covered topics are:

- Installation and wiring
- Commissioning and diagnostics
- Components
- Article numbers
- Technical specifications

1.4 Technical support:

Please contact your local ELCO representative or call hotline if you have any questions about the products described in this manual.

Additional information about ELCO products is available:

Corporate name: Tianjin Elco Automation Co., Ltd

Company address: No. 12, 4th XEDA Branch Road, Xiqing Economic-Technological Development Area ,Tianjin China

Website: <https://www.elcoautomation.com/en-us/>

TEL: +86 22 23888288

1.5 Electrical installation:



WARNING

Danger due to electrical voltage!

An unqualified installation can affect the use of the equipment or lead to equipment damage!

- Only qualified electrical engineering personnel may install the modules.
- Only operate on 24 V DC voltage.
- Input power supply must be connected to limited power source (LPS).
- Output power supplies with SELV/PELV.
- Use Copper Conductors Only. Use min. 22AWG for IO-Link port connector and min. 18AWG for auxiliary power connector and min. 26AWG for Signal I/O connector.

ATTENTION

La tension pose un danger!

Une installation non conforme peut affecter l'utilisation de l'appareil ou causer des dommages à l'appareil!

- Seuls les ingénieurs électriciens qualifiés peuvent installer les modules.
- Fonctionne uniquement à 24 V DC.
- L'alimentation d'entrée doit être connectée à une alimentation limitée (LPS).
- Alimentation de sortie avec SELV/PELV.
- Utilisez uniquement des fils de cuivre. Utiliser la valeur minimale. 22AWG pour connecteurs IO-Link Port et min. 18AWG pour connecteur d'alimentation auxiliaire et min. 26AWG est utilisé pour les connecteurs E/S de signal.

1.6 Disclaimer of liability:



- Only qualified personnel may perform installation, commissioning, modification, inspection and retrofitting activities.
- Follow the applicable regulations and standards in the operating instructions and manual.
- Follow the safety regulations of the Employers' Liability Insurance Association and electrical engineering.

If the equipment is used in a manner not specified by the manufacturer, the protection provided by the equipment may be impaired. We assume no liability for product damage or subsequent damage arising from non-observance of the regulations or improper handling of the products.

2.1 Datasheet

LKHA-0032N-TA

ARTICLE PROPERTIES

PRODUCT TYPE	IO-Link IP20 hubs-32 digital I/O modules
DESCRIPTION	32DO, NPN, interface 4-Pos terminals

ELECTRICAL CONNECTION

IO-LINK	1 × 4-Pos terminals	INPUT / OUTPUT	4 × 10 position I/O terminal blocks + 4 × 10 position Aux-plugs (24 V and 0 V) terminal blocks, Push-in spring connection, Pluggable
POWER SUPPLY	IO-Link interface + Power supply terminals (Us + Ua)		

ELECTRICAL PARAMETERS

INPUT CHANNELS	-	OUTPUT	32
INPUT SUPPLY CURRENT	-	OUTPUT CURRENT	Max. 500 mA per channel, sum 6 A
INPUT DELAY	-	OUTPUT TYPE	Lamps, solenoidvalve, etc.
MODULE COMMUNICATION INDICATOR	Green LED	OUTPUT FREQUENCY	Resistive load 100 Hz, Inductive load 5 Hz
POWER SUPPLY INDICATOR	Green LED	PROCESS DATA IN	0 bytes
SIGNAL STATUS INDICATOR	Green LED	PROCESS DATA OUT	4 bytes

DIAGNOSTICS

COMMUNICATION STATUS	LED indication, communication message	SHORT-CIRCUIT	LED indication
VOLTAGE DETECTION	LED indication	OVERLOAD	LED indication

FUNCTIONAL SAFETY

MTTF (40 °C)	82a
---------------------	-----

GENERAL DATA

PROTECTION CLASS	IP20	OPERATING TEMPERATURE	-25 ... +70 °C
DIMENSIONS	120 × 70 × 39 mm	STORAGE TEMPERATURE	-40 ... +85 °C
WEIGHT	204.95 g		

LKHA-0032N-TC

ARTICLE PROPERTIES

PRODUCT TYPE	IO-Link IP20 hubs-32 digital I/O modules
DESCRIPTION	32DO, NPN, interface 4-Pos terminals

ELECTRICAL CONNECTION

IO-LINK	1 × 4-Pos terminals	INPUT / OUTPUT	4 × 10 position I/O terminal blocks, push-in spring connection, pluggable
POWER SUPPLY	IO-Link interface + Power supply terminals (Us + Ua)		

ELECTRICAL PARAMETERS

INPUT CHANNELS	-	OUTPUT	32
INPUT SUPPLY CURRENT	-	OUTPUT CURRENT	Max. 500 mA per channel, sum 6 A
INPUT DELAY	-	OUTPUT TYPE	Lamps, solenoidvalve, etc.
MODULE COMMUNICATION INDICATOR	Green LED	OUTPUT FREQUENCY	Resistive load 100 Hz, Inductive load 5 Hz
POWER SUPPLY INDICATOR	Green LED	PROCESS DATA IN	0 bytes
SIGNAL STATUS INDICATOR	Green LED	PROCESS DATA OUT	4 bytes

DIAGNOSTICS

COMMUNICATION STATUS	LED indication, communication message	SHORT-CIRCUIT	LED indication
VOLTAGE DETECTION	LED indication	OVERLOAD	LED indication

FUNCTIONAL SAFETY

MTTF (40 °C)	82a
---------------------	-----

GENERAL DATA

PROTECTION CLASS	IP20	OPERATING TEMPERATURE	-25 ... +70 °C
DIMENSIONS	120 × 70 × 39 mm	STORAGE TEMPERATURE	-40 ... +85 °C
WEIGHT	204.95 g		

LKHA-3200P-TA

ARTICLE PROPERTIES

PRODUCT TYPE	IO-Link IP20 hubs-32 digital I/O modules
DESCRIPTION	32DI, PNP, interface 4-Pos terminals

ELECTRICAL CONNECTION

IO-LINK	1 × 4-Pos terminals	INPUT / OUTPUT	4 × 10 position I/O terminal blocks + 4 × 10 position Aux-plugs (24 V and 0 V) terminal blocks, Push-in spring connection, Pluggable
POWER SUPPLY	IO-Link interface + Power supply terminals (Us + Ua)		

ELECTRICAL PARAMETERS

INPUT CHANNELS	32	OUTPUT	-
INPUT SUPPLY CURRENT	Max. 200 mA per channel, sum 1.6 A (without Ua) / 6 A (with Ua)	OUTPUT CURRENT	-
INPUT DELAY	0.8 ms, 1.6 ms, 3.2 ms or 20 ms, parameterizable configuration	OUTPUT TYPE	-
MODULE COMMUNICATION INDICATOR	Green LED	OUTPUT FREQUENCY	-
POWER SUPPLY INDICATOR	Green LED	PROCESS DATA IN	4 bytes
SIGNAL STATUS INDICATOR	Green LED	PROCESS DATA OUT	0 bytes

DIAGNOSTICS

COMMUNICATION STATUS	LED indication, communication message	SHORT-CIRCUIT	LED indication
VOLTAGE DETECTION	LED indication	OVERLOAD	LED indication

FUNCTIONAL SAFETY

MTTF (40 °C)	120a
---------------------	------

GENERAL DATA

PROTECTION CLASS	IP20	OPERATING TEMPERATURE	-25 ... +70 °C
DIMENSIONS	120 × 70 × 39 mm	STORAGE TEMPERATURE	-40 ... +85 °C
WEIGHT	204.95 g		

LKHA-3200P-TC

ARTICLE PROPERTIES

PRODUCT TYPE	IO-Link IP20 hubs-32 digital I/O modules
DESCRIPTION	32DI, PNP, interface 4-Pos terminals

ELECTRICAL CONNECTION

IO-LINK	1 × 4-Pos terminals	INPUT / OUTPUT	4 × 10 position I/O terminal blocks, push-in spring connection, pluggable
POWER SUPPLY	IO-Link interface + Power supply terminals (Us + Ua)		

ELECTRICAL PARAMETERS

INPUT CHANNELS	32	OUTPUT	-
INPUT SUPPLY CURRENT	Max. 200 mA per channel, sum 1.6 A (without Ua) / 6 A (with Ua)	OUTPUT CURRENT	-
INPUT DELAY	0.8 ms, 1.6 ms, 3.2 ms or 20 ms, parameterizable configuration	OUTPUT TYPE	-
MODULE COMMUNICATION INDICATOR	Green LED	OUTPUT FREQUENCY	-
POWER SUPPLY INDICATOR	Green LED	PROCESS DATA IN	4 bytes
SIGNAL STATUS INDICATOR	Green LED	PROCESS DATA OUT	0 bytes

DIAGNOSTICS

COMMUNICATION STATUS	LED indication, communication message	SHORT-CIRCUIT	LED indication
VOLTAGE DETECTION	LED indication	OVERLOAD	LED indication

FUNCTIONAL SAFETY

MTTF (40 °C)	120a
---------------------	------

GENERAL DATA

PROTECTION CLASS	IP20	OPERATING TEMPERATURE	-25 ... +70 °C
DIMENSIONS	120 × 70 × 39 mm	STORAGE TEMPERATURE	-40 ... +85 °C
WEIGHT	204.95 g		

LKHA-0032P-TA

ARTICLE PROPERTIES

PRODUCT TYPE	IO-Link IP20 hubs-32 digital I/O modules
DESCRIPTION	32DO, PNP, interface 4-Pos terminals

ELECTRICAL CONNECTION

IO-LINK	1 × 4-Pos terminals	INPUT / OUTPUT	4 × 10 position I/O terminal blocks + 4 × 10 position Aux-plugs (24 V and 0 V) terminal blocks, Push-in spring connection, Pluggable
POWER SUPPLY	IO-Link interface + Power supply terminals (Us + Ua)		

ELECTRICAL PARAMETERS

INPUT CHANNELS	-	OUTPUT	32
INPUT SUPPLY CURRENT	-	OUTPUT CURRENT	Max. 500 mA per channel, sum 6 A
INPUT DELAY	-	OUTPUT TYPE	Lamps, solenoidvalve, etc.
MODULE COMMUNICATION INDICATOR	Green LED	OUTPUT FREQUENCY	Resistive load 100 Hz, Inductive load 5 Hz
POWER SUPPLY INDICATOR	Green LED	PROCESS DATA IN	0 bytes
SIGNAL STATUS INDICATOR	Green LED	PROCESS DATA OUT	4 bytes

DIAGNOSTICS

COMMUNICATION STATUS	LED indication, communication message	SHORT-CIRCUIT	LED indication
VOLTAGE DETECTION	LED indication	OVERLOAD	LED indication

FUNCTIONAL SAFETY

MTTF (40 °C)	90a
---------------------	-----

GENERAL DATA

PROTECTION CLASS	IP20	OPERATING TEMPERATURE	-25 ... +70 °C
DIMENSIONS	120 × 70 × 39 mm	STORAGE TEMPERATURE	-40 ... +85 °C
WEIGHT	204.95 g		

LKHA-0032P-TC

ARTICLE PROPERTIES

PRODUCT TYPE	IO-Link IP20 hubs-32 digital I/O modules
DESCRIPTION	32DO, PNP, interface 4-Pos terminals

ELECTRICAL CONNECTION

IO-LINK	1 × 4-Pos terminals	INPUT / OUTPUT	4 × 10 position I/O terminal blocks, push-in spring connection, pluggable
POWER SUPPLY	IO-Link interface + Power supply terminals (Us + Ua)		

ELECTRICAL PARAMETERS

INPUT CHANNELS	-	OUTPUT	32
INPUT SUPPLY CURRENT	-	OUTPUT CURRENT	Max. 500 mA per channel, sum 6 A
INPUT DELAY	-	OUTPUT TYPE	Lamps, solenoidvalve, etc.
MODULE COMMUNICATION INDICATOR	Green LED	OUTPUT FREQUENCY	Resistive load 100 Hz, Inductive load 5 Hz
POWER SUPPLY INDICATOR	Green LED	PROCESS DATA IN	0 bytes
SIGNAL STATUS INDICATOR	Green LED	PROCESS DATA OUT	4 bytes

DIAGNOSTICS

COMMUNICATION STATUS	LED indication, communication message	SHORT-CIRCUIT	LED indication
VOLTAGE DETECTION	LED indication	OVERLOAD	LED indication

FUNCTIONAL SAFETY

MTTF (40 °C)	90a
---------------------	-----

GENERAL DATA

PROTECTION CLASS	IP20	OPERATING TEMPERATURE	-25 ... +70 °C
DIMENSIONS	120 × 70 × 39 mm	STORAGE TEMPERATURE	-40 ... +85 °C
WEIGHT	204.95 g		

LKHA-1616N-TA

ARTICLE PROPERTIES

PRODUCT TYPE	IO-Link IP20 hubs-32 digital I/O modules
DESCRIPTION	16DI / 16DO, NPN, interface 4-Pos terminals

ELECTRICAL CONNECTION

IO-LINK	1 × 4-Pos terminals	INPUT / OUTPUT	4 × 10 position I/O terminal blocks + 4 × 10 position Aux-plugs (24 V and 0 V) terminal blocks, Push-in spring connection, Pluggable
POWER SUPPLY	IO-Link interface + Power supply terminals (Us + Ua)		

ELECTRICAL PARAMETERS

INPUT CHANNELS	16	OUTPUT	16
INPUT SUPPLY CURRENT	Max. 200 mA per channel, sum 1.6 A	OUTPUT CURRENT	Max. 500 mA per channel, sum 6 A
INPUT DELAY	0.8 ms, 1.6 ms, 3.2 ms or 20 ms, parameterizable configuration	OUTPUT TYPE	Lamps, solenoidvalve, etc.
MODULE COMMUNICATION INDICATOR	Green LED	OUTPUT FREQUENCY	Resistive load 100 Hz, Inductive load 5 Hz
POWER SUPPLY INDICATOR	Green LED	PROCESS DATA IN	2 bytes
SIGNAL STATUS INDICATOR	Green LED	PROCESS DATA OUT	2 bytes

DIAGNOSTICS

COMMUNICATION STATUS	LED indication, communication message	SHORT-CIRCUIT	LED indication
VOLTAGE DETECTION	LED indication	OVERLOAD	LED indication

FUNCTIONAL SAFETY

MTTF (40 °C)	91a
---------------------	-----

GENERAL DATA

PROTECTION CLASS	IP20	OPERATING TEMPERATURE	-25 ... +70 °C
DIMENSIONS	120 × 70 × 39 mm	STORAGE TEMPERATURE	-40 ... +85 °C
WEIGHT	204.95 g		

LKHA-1616N-TC

ARTICLE PROPERTIES

PRODUCT TYPE	IO-Link IP20 hubs-32 digital I/O modules
DESCRIPTION	16DI / 16DO, NPN, interface 4-Pos terminals

ELECTRICAL CONNECTION

IO-LINK	1 × 4-Pos terminals	INPUT / OUTPUT	4 × 10 position I/O terminal blocks, push-in spring connection, pluggable
POWER SUPPLY	IO-Link interface + Power supply terminals (Us + Ua)		

ELECTRICAL PARAMETERS

INPUT CHANNELS	16	OUTPUT	16
INPUT SUPPLY CURRENT	Max. 200 mA per channel, sum 1.6 A	OUTPUT CURRENT	Max. 500 mA per channel, sum 6 A
INPUT DELAY	0.8 ms, 1.6 ms, 3.2 ms or 20 ms, parameterizable configuration	OUTPUT TYPE	Lamps, solenoidvalve, etc.
MODULE COMMUNICATION INDICATOR	Green LED	OUTPUT FREQUENCY	Resistive load 100 Hz, Inductive load 5 Hz
POWER SUPPLY INDICATOR	Green LED	PROCESS DATA IN	2 bytes
SIGNAL STATUS INDICATOR	Green LED	PROCESS DATA OUT	2 bytes

DIAGNOSTICS

COMMUNICATION STATUS	LED indication, communication message	SHORT-CIRCUIT	LED indication
VOLTAGE DETECTION	LED indication	OVERLOAD	LED indication

FUNCTIONAL SAFETY

MTTF (40 °C)	91a
---------------------	-----

GENERAL DATA

PROTECTION CLASS	IP20	OPERATING TEMPERATURE	-25 ... +70 °C
DIMENSIONS	120 × 70 × 39 mm	STORAGE TEMPERATURE	-40 ... +85 °C
WEIGHT	204.95 g		

LKHA-1616P-TA

ARTICLE PROPERTIES

PRODUCT TYPE	IO-Link IP20 hubs-32 digital I/O modules
DESCRIPTION	16DI / 16DO, PNP, interface 4-Pos terminals

ELECTRICAL CONNECTION

IO-LINK	1 × 4-Pos terminals	INPUT / OUTPUT	4 × 10 position I/O terminal blocks + 4 × 10 position Aux-plugs (24 V and 0 V) terminal blocks, Push-in spring connection, Pluggable
POWER SUPPLY	IO-Link interface + Power supply terminals (Us + Ua)		

ELECTRICAL PARAMETERS

INPUT CHANNELS	16	OUTPUT	16
INPUT SUPPLY CURRENT	Max. 200 mA per channel, sum 1.6 A	OUTPUT CURRENT	Max. 500 mA per channel, sum 6 A
INPUT DELAY	0.8 ms, 1.6 ms, 3.2 ms or 20 ms, parameterizable configuration	OUTPUT TYPE	Lamps, solenoidvalve, etc.
MODULE COMMUNICATION INDICATOR	Green LED	OUTPUT FREQUENCY	Resistive load 100 Hz, Inductive load 5 Hz
POWER SUPPLY INDICATOR	Green LED	PROCESS DATA IN	2 bytes
SIGNAL STATUS INDICATOR	Green LED	PROCESS DATA OUT	2 bytes

DIAGNOSTICS

COMMUNICATION STATUS	LED indication, communication message	SHORT-CIRCUIT	LED indication
VOLTAGE DETECTION	LED indication	OVERLOAD	LED indication

FUNCTIONAL SAFETY

MTTF (40 °C)	110a
---------------------	------

GENERAL DATA

PROTECTION CLASS	IP20	OPERATING TEMPERATURE	-25 ... +70 °C
DIMENSIONS	120 × 70 × 39 mm	STORAGE TEMPERATURE	-40 ... +85 °C
WEIGHT	204.95 g		

LKHA-1616P-TC

ARTICLE PROPERTIES

PRODUCT TYPE	IO-Link IP20 hubs-32 digital I/O modules
DESCRIPTION	16DI / 16DO, PNP, interface 4-Pos terminals

ELECTRICAL CONNECTION

IO-LINK	1 × 4-Pos terminals	INPUT / OUTPUT	4 × 10 position I/O terminal blocks, push-in spring connection, pluggable
POWER SUPPLY	IO-Link interface + Power supply terminals (Us + Ua)		

ELECTRICAL PARAMETERS

INPUT CHANNELS	16	OUTPUT	16
INPUT SUPPLY CURRENT	Max. 200 mA per channel, sum 1.6 A	OUTPUT CURRENT	Max. 500 mA per channel, sum 6 A
INPUT DELAY	0.8 ms, 1.6 ms, 3.2 ms or 20 ms, parameterizable configuration	OUTPUT TYPE	Lamps, solenoidvalve, etc.
MODULE COMMUNICATION INDICATOR	Green LED	OUTPUT FREQUENCY	Resistive load 100 Hz, Inductive load 5 Hz
POWER SUPPLY INDICATOR	Green LED	PROCESS DATA IN	2 bytes
SIGNAL STATUS INDICATOR	Green LED	PROCESS DATA OUT	2 bytes

DIAGNOSTICS

COMMUNICATION STATUS	LED indication, communication message	SHORT-CIRCUIT	LED indication
VOLTAGE DETECTION	LED indication	OVERLOAD	LED indication

FUNCTIONAL SAFETY

MTTF (40 °C)	110a
---------------------	------

GENERAL DATA

PROTECTION CLASS	IP20	OPERATING TEMPERATURE	-25 ... +70 °C
DIMENSIONS	120 × 70 × 39 mm	STORAGE TEMPERATURE	-40 ... +85 °C
WEIGHT	204.95 g		

LKHA-3200N-TA

ARTICLE PROPERTIES

PRODUCT TYPE	IO-Link IP20 hubs-32 digital I/O modules
DESCRIPTION	32DI, NPN, interface 4-Pos terminals

ELECTRICAL CONNECTION

IO-LINK	1 × 4-Pos terminals	INPUT / OUTPUT	4 × 10 position I/O terminal blocks + 4 × 10 position Aux-plugs (24 V and 0 V) terminal blocks, Push-in spring connection, Pluggable
POWER SUPPLY	IO-Link interface + Power supply terminals (Us + Ua)		

ELECTRICAL PARAMETERS

INPUT CHANNELS	32	OUTPUT	-
INPUT SUPPLY CURRENT	Max. 200 mA per channel, sum 1.6 A (without Ua) / 6 A (with Ua)	OUTPUT CURRENT	-
INPUT DELAY	0.8 ms, 1.6 ms, 3.2 ms or 20 ms, parameterizable configuration	OUTPUT TYPE	-
MODULE COMMUNICATION INDICATOR	Green LED	OUTPUT FREQUENCY	-
POWER SUPPLY INDICATOR	Green LED	PROCESS DATA IN	4 bytes
SIGNAL STATUS INDICATOR	Green LED	PROCESS DATA OUT	0 bytes

DIAGNOSTICS

COMMUNICATION STATUS	LED indication, communication message	SHORT-CIRCUIT	LED indication
VOLTAGE DETECTION	LED indication	OVERLOAD	LED indication

FUNCTIONAL SAFETY

MTTF (40 °C)	98a
---------------------	-----

GENERAL DATA

PROTECTION CLASS	IP20	OPERATING TEMPERATURE	-25 ... +70 °C
DIMENSIONS	120 × 70 × 39 mm	STORAGE TEMPERATURE	-40 ... +85 °C
WEIGHT	204.95 g		

LKHA-3200N-TC

ARTICLE PROPERTIES

PRODUCT TYPE	IO-Link IP20 hubs-32 digital I/O modules
DESCRIPTION	32DI, NPN, interface 4-Pos terminals

ELECTRICAL CONNECTION

IO-LINK	1 × 4-Pos terminals	INPUT / OUTPUT	4 × 10 position I/O terminal blocks, push-in spring connection, pluggable
POWER SUPPLY	IO-Link interface + Power supply terminals (Us + Ua)		

ELECTRICAL PARAMETERS

INPUT CHANNELS	32	OUTPUT	-
INPUT SUPPLY CURRENT	Max. 200 mA per channel, sum 1.6 A (without Ua) / 6 A (with Ua)	OUTPUT CURRENT	-
INPUT DELAY	0.8 ms, 1.6 ms, 3.2 ms or 20 ms, parameterizable configuration	OUTPUT TYPE	-
MODULE COMMUNICATION INDICATOR	Green LED	OUTPUT FREQUENCY	-
POWER SUPPLY INDICATOR	Green LED	PROCESS DATA IN	4 bytes
SIGNAL STATUS INDICATOR	Green LED	PROCESS DATA OUT	0 bytes

DIAGNOSTICS

COMMUNICATION STATUS	LED indication, communication message	SHORT-CIRCUIT	LED indication
VOLTAGE DETECTION	LED indication	OVERLOAD	LED indication

FUNCTIONAL SAFETY

MTTF (40 °C)	98a
---------------------	-----

GENERAL DATA

PROTECTION CLASS	IP20	OPERATING TEMPERATURE	-25 ... +70 °C
DIMENSIONS	120 × 70 × 39 mm	STORAGE TEMPERATURE	-40 ... +85 °C
WEIGHT	204.95 g		

2.2 LED indicator

IO-Link signal hub indicator

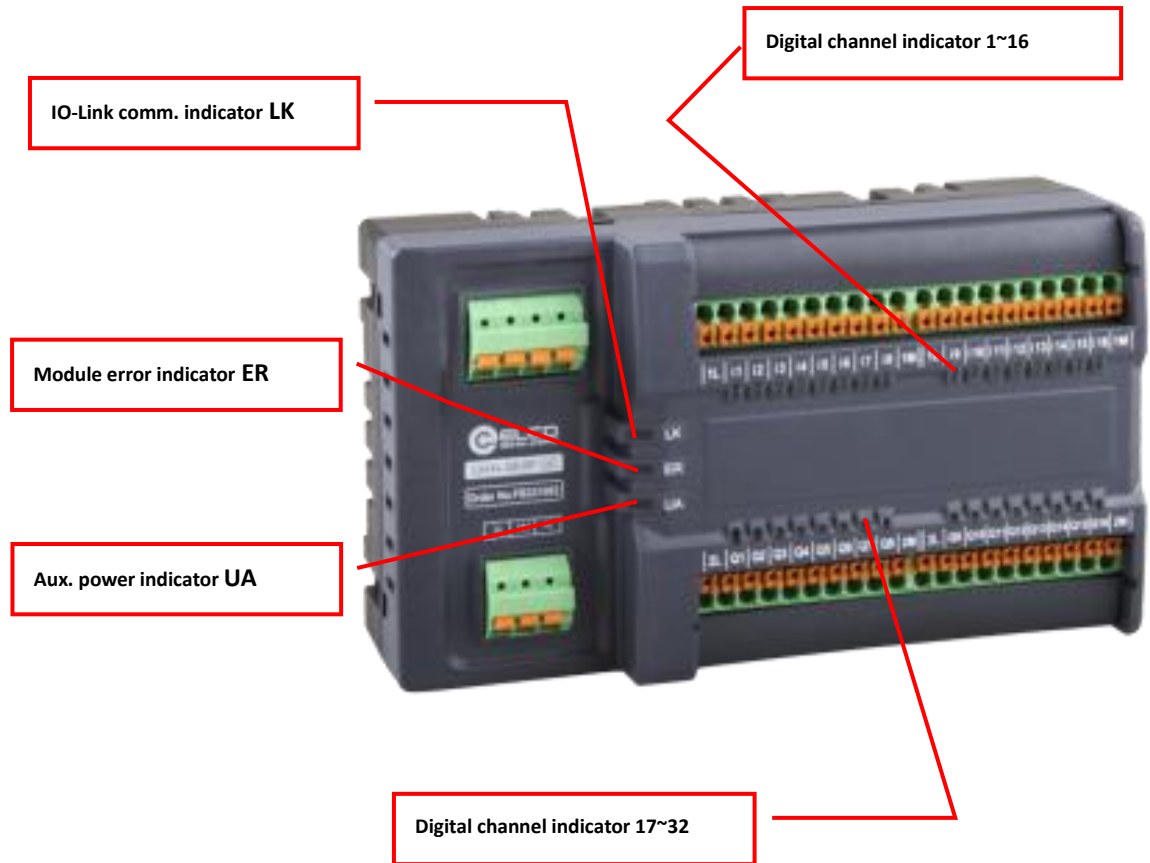

2.3 IO-Link signal hub dimensions

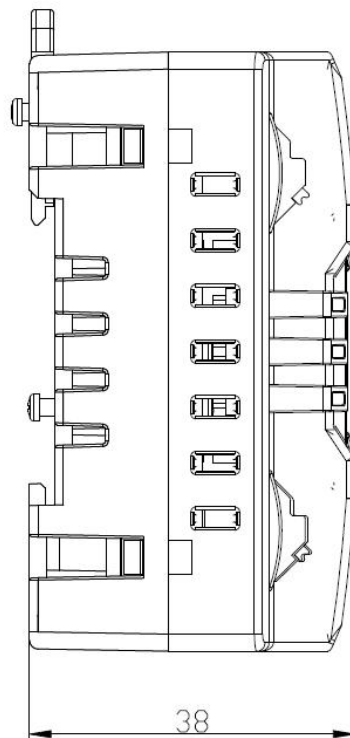
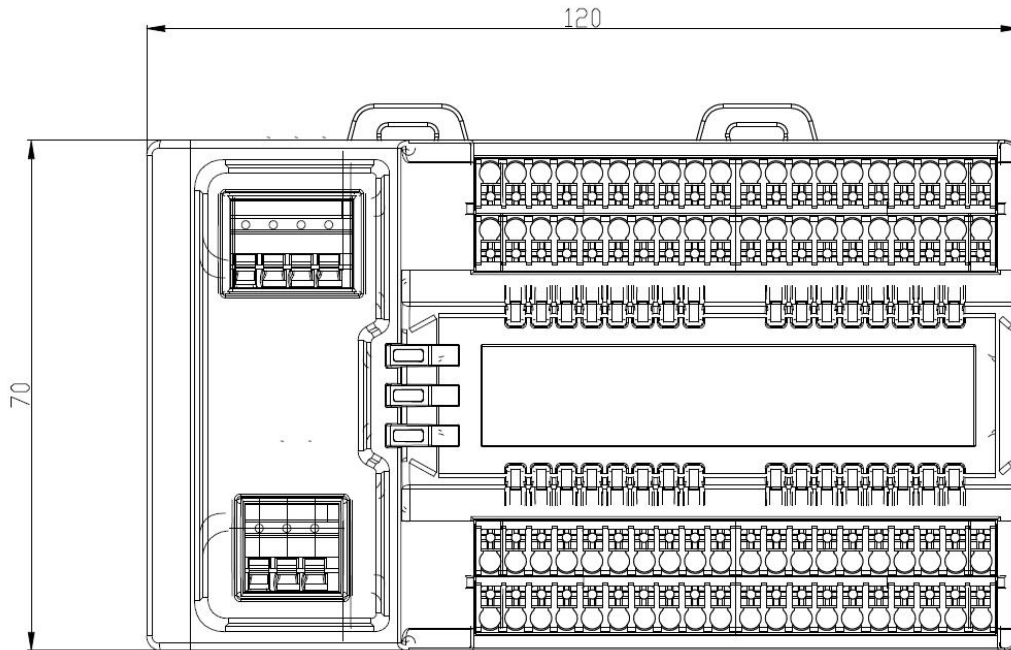

2.4 Mounting the module

This series of products can be directly installed on DIN35 standard rails

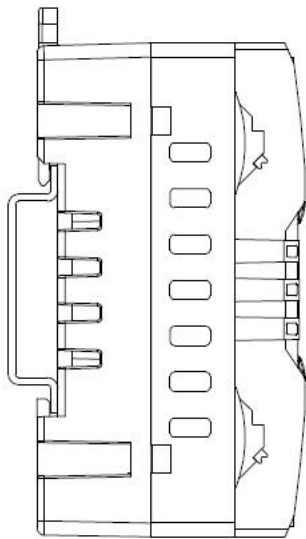
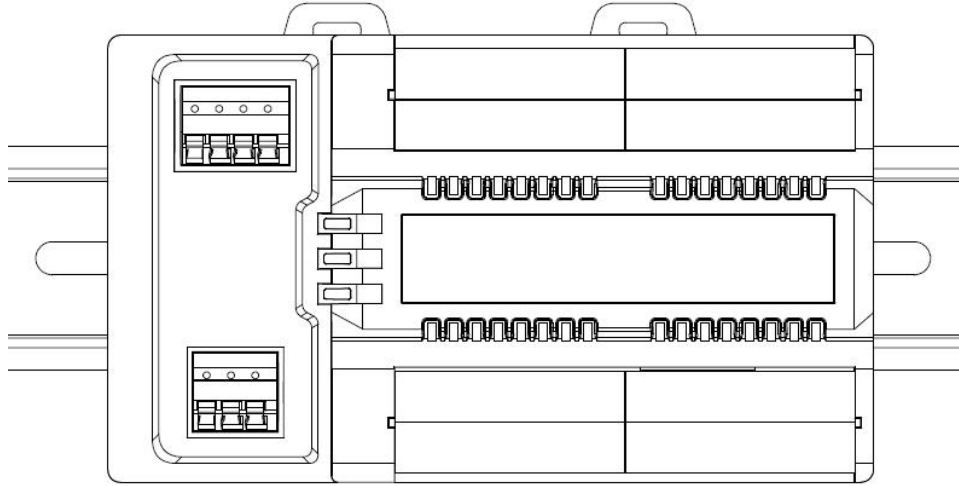

2.5 Wiring

Please make sure to cut off power supply when wiring to ensure safety.

- 1) IO-Link port connector (M12 A-Code 4-pin, Male)



Terminal	Class-A
1	1L Power supply 24V+ (Us)
2	-
3	1M Power supply GND (Us)
4	IO-Link C/Q

- 2) Auxiliary power connector (3-Pos Terminals)

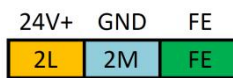

Terminal	Terminals
2L	Aux. Power supply 24V+ (Ua)
2M	Aux. Power supply GND (Ua)
FE	Function Earth

- 3) Wiring example

- A) PNP input signal – LKHA-3200P-TC, LKHA-1616P-TC, LKHA-3200P-TA, LKHA-1616P-TA support this connection.

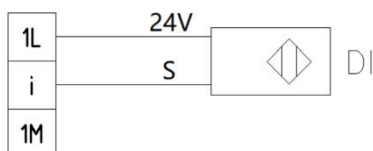

- B) PNP output signal – LKHA-1616P-TC, LKHA-0032P-TC, LKHA-1616P-TA, LKHA-0032P-TA support this connection.

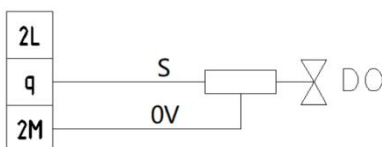

- C) NPN input signal – LKHA-3200N-TC, LKHA-1616N-TC, LKHA-3200N-TA, LKHA-1616N-TA support this connection.

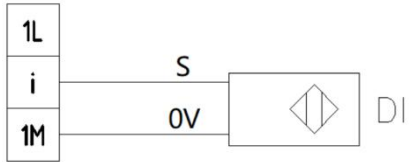

D) NPN output signal – LKHA-1616N-TC, LKHA-0032N-TC, LKHA-1616N-TA, LKHA-0032N-TA support this connection.

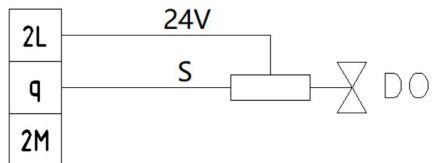

E) Analog input signal – LKHA-08UA-TC support this connection.

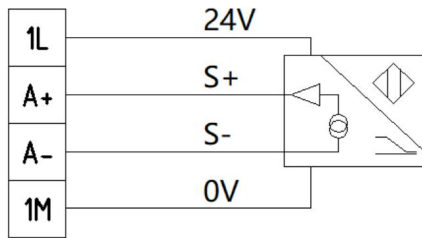

F) Analog output signal – LKHA-08UA-TC support this connection

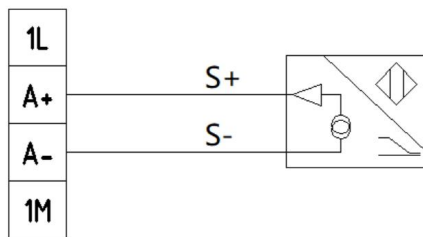

2.6 IO-Link signal hub indicator

Name	Status	Meaning	Fault cause
Module communication Indicator LK	Green flash	Receive IO-Link communication	–
	Off	No IO-Link signal received	1.Expansion cable failure 2.Master IO-Link port problem 3.Slave module is damaged
Module ERROR Indicator ER	Green	No error	–
	Red	Working abnormally	1. Power supply is abnormal 2.Channel abnormal (short circuit, overload, etc.) 3. Module is damaged
Power supply Indicator UA	Green	Supply voltage normal	
	Off	No power supply	1.Power supply cable failure 2. Module is damaged
Signal / status Indicator	Red	Abnormal signal	1.Signal overload or short circuit 2.Slave module is damaged
	Green	Have signal	–
	Off	No signal	–