

Product Description:

- Metal casing, 150m laser beam, coaxial technology, no blind spots, precise positioning, wide voltage power supply.
- Suitable for automotive manufacturing, metallurgical industry, non-standard equipment, textile machinery, etc

Product features:

- Long detection distance
- Adjust sensitivity by adjusting the knob
- IP67 protection rating
- Push-pull output mode

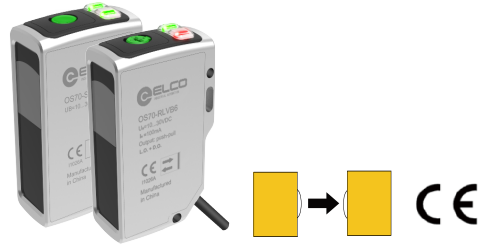

| Type | Distance | light source | Output | Connection | Wiring |
|------------------------------|----------|---------------|-----------|------------|--------|
| OMS70-SL6 *M ¹⁾ | 150m | Laser Class I | — — | Cable | Fig.1 |
| OMS70-ELVB6 *M ¹⁾ | 150m | Laser Class I | Push-pull | Cable | Fig.2 |

Note 1): * M refers to the cable length in meters. If there is no * M in the model, the default cable length is 2 meters.

TECHNICAL SPECIFICATION

| | | | |
|-------------------------------------|------------------------|--------------------------------------|--|
| OPERATING VOLTAGE | 10...30VDC | AMBIENT TEMPERATURE OPERATION | -20°C...+60°C |
| RIPPLE VOLTAGE | ±10% of U _B | AMBIENT TEMPERATURE STORAGE | -40°C...+70°C |
| BEAM | Laser Class I | CIRCUIT PROTECTION | Short-circuit protection, Reverse polarity protection, |
| OUTPUT SWITCHING | Light+Dark | PROTECTION DEGREE | IP67 |
| LOAD CURRENT | ≤100mA | HOUSING | Die-Casting Zinc |
| EMISSION CONSUMPTION CURRENT | ≤15mA | CONNECTING TYPE | Cable |
| RECEIVE CONSUMPTION CURRENT | ≤20mA | RESPONSE FREQUENCY | 800Hz |
| SENSITIVITY(RECEIVING) | Rotary Switch | | |
| RECEIVE STATE INDICATION | Green LED | | |
| OUTPUT STATE INDICATION | Red LED | | |
| POWER INDICATION | Green LED | | |

DIMENSIONS

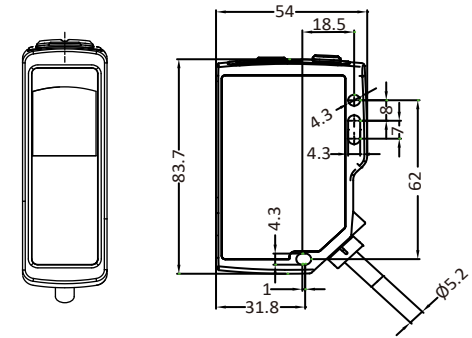
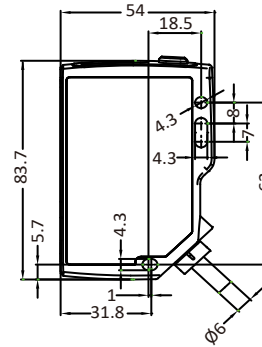

INDICATORS

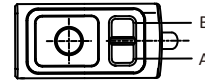

| | | |
|---|-------|-------|
| A | Pweer | Green |
| B | Power | Green |

ELECTRICAL CONNECTION

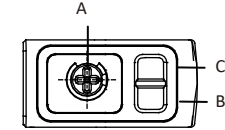

| | | |
|---|------------------|-------|
| A | Potentiometer | |
| B | Output indicator | Red |
| C | Stable indicator | Green |

ELECTRICAL CONNECTION

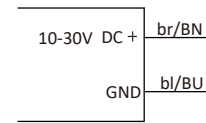

Fig.1

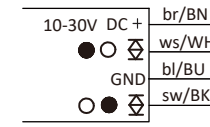

Fig.2

○ = Light on
● = Drak on

ELSAFETY WARINGS

IEC 60825-1:2014
EN 60825-1:2014+A11:2021
Maximum output:3mW,pulse duration:3,2us,wavelength:658nm
Beam divergence: 1 mrad

The laser can be turned off by turning off the power.
Please read the instruction before installing the product to ensure the product is suitable.
Please follow the standard rules used in the instruction.
Please contact your local ELCO representative or call hotline if you have any questions about the products described in this instruction.

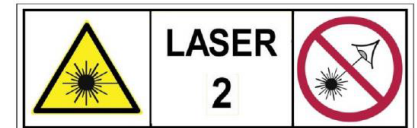

产品说明:

- 金属外壳, 150m激光对射。采用同轴技术, 无盲区, 精准定位, 宽电压供电
- 适用于汽车制造、冶金行业、非标设备、纺织机械等应用

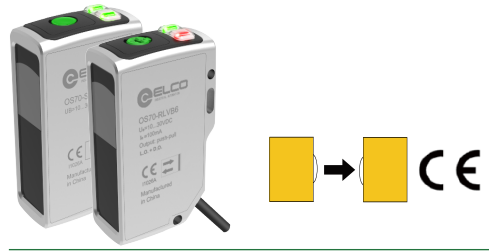

产品特点:

- 检测距离长
- 通过调节旋钮调节灵敏度
- IP67防护等级
- 推挽输出



| 型号 | 检测距离 | 光源 | 输出方式 | 连接方式 | 接线图 |
|------------------------------|------|-----------|------|------|-----|
| OSM70-SL6 *M ¹⁾ | 150m | 激光Class I | — — | 线缆 | 图1 |
| OSM70-ELVB6 *M ¹⁾ | 150m | 激光Class I | 推挽 | 线缆 | 图2 |

注1): *M表示线缆长度, 单位米, 型号中无*M默认线缆长度为2米。

技术参数

| | | | |
|----------|------------------------|--------|---------------|
| 工作电压 | 10...30VDC | 工作环境温度 | -20°C...+60°C |
| 消耗电流 | ≤25mA | 储存环境温度 | -40°C...+70°C |
| 纹波电压 | ±10% of U _B | 保护电路 | 短路保护 反极性保护 |
| 光源 | 激光 Class I | 防护等级 | IP67 |
| 输出特性 | 亮态+暗态 | 外壳 | 压铸件 |
| 负载电流 | ≤100mA | 连接方式 | 线缆式 |
| 发射消耗电流 | ≤15mA | 响应频率 | 800Hz |
| 接收消耗电流 | ≤20mA | | |
| 灵敏度 (接收) | 单圈旋钮 | | |
| 接收状态指示灯 | 绿色LED | | |
| 接收状态指示灯 | 红色LED | | |
| 电源指示灯 | 绿色LED | | |

外形尺寸

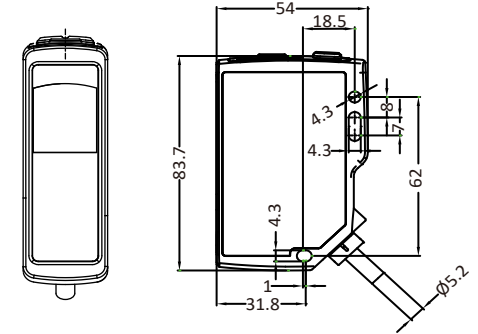
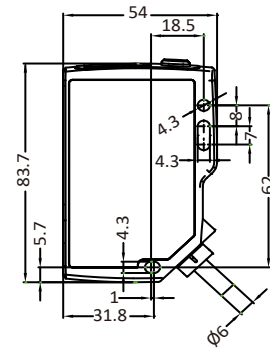

发射指示图

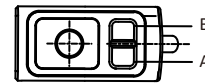

| | | |
|---|-------|----|
| A | 电源指示灯 | 绿色 |
| B | 电源指示灯 | 绿色 |

接收指示图

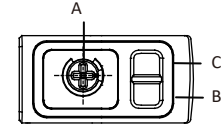

| | | |
|---|---------|----|
| A | 电位计 | |
| B | 输出状态指示灯 | 红色 |
| C | 接收状态指示灯 | 绿色 |

接线图



图1



图2

○ = 亮通
● = 暗通

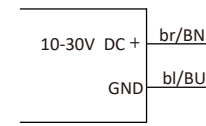
安全警告

IEC 60825-1:2014
EN 60825-1:2014+A11:2021
最大输出: 3mW, 脉冲宽度: 3, 2us, 波长: 658nm
光束发散角: 1 mrad

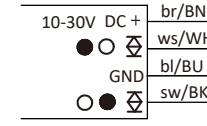
可通过切断电源来关闭激光
安装产品前请阅读本说明书, 确保产品适用。
请遵守说明书中使用的标准规则。
如您对说明书中的描述有任何疑问, 请联系当地ELCO代表或致电ELCO。

