

产品说明:

- 金属外壳, 3m/4m激光GBS漫反射检测距离。采用同轴技术, 无盲区, 精准定位, 宽电压供电
- 适用于汽车制造、冶金行业、非标设备、纺织机械等应用



产品特点:

- BGS功能极大提升检测效果
- 检测距离长
- 通过按键调节灵敏度
- IP67防护等级
- 推挽式输出

型号	检测距离	光源	输出方式	连接方式	接线图
OSM70-AKL3000VR6 *M ¹⁾	0.1m...3m	红外激光Class I	推挽	线缆	图1
OSM70-AKL4000VR6 *M ¹⁾	0.1m...4m	红外激光Class I	推挽	线缆	图1
OSM70-AKL3000VR6Q	0.1m...3m	红外激光Class I	推挽	M12连接器	图2
OSM70-AKL4000VR6Q	0.1m...4m	红外激光Class I	推挽	M12连接器	图2

注1): *M表示线缆长度, 单位米, 型号中无*M默认线缆长度为2米。

技术参数

工作电压	10...30VDC	工作环境温度	-20°C...+50°C
纹波电压	±10% of U _s	储存环境温度	-40°C...+70°C
检测光源	红外VCSEL光源 (940nm)	保护电路	短路保护 反极性保护
指示光源	红光激光(655nm)	防护等级	IP67
输出特性	亮态+暗态	外壳	压铸件
负载电流	≤100mA	连接方式	线缆式 M12连接器
消耗电流	≤50mA	开关频率	20-50Hz
重复精度	20mm		
电源指示灯	绿色LED		
输出状态指示灯	红色LED		

外形尺寸

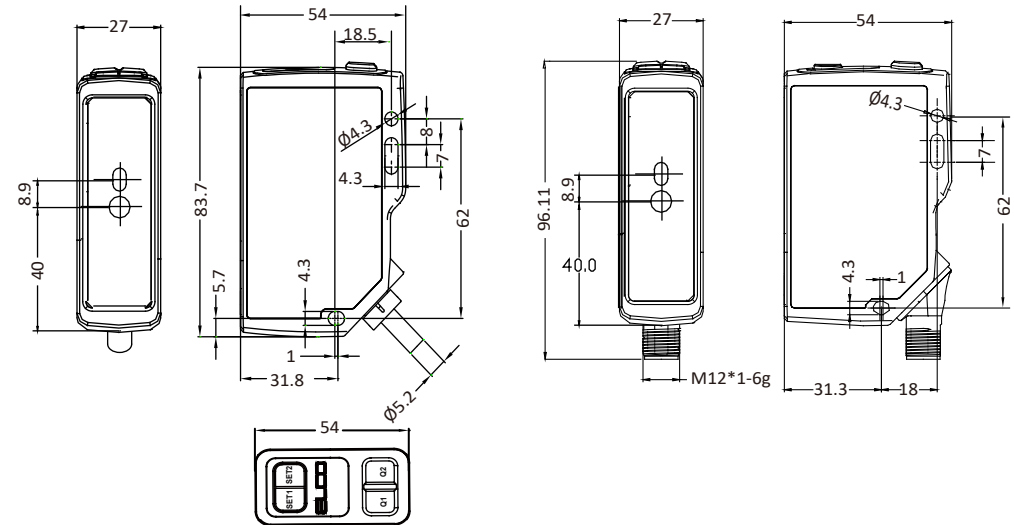

操作指示



A	设置1	
B	设置2	
C	电源指示灯	红色
D	输出状态指示灯	绿色

接线图



图1

图2

○ = 亮通
● = 暗通

安全警示

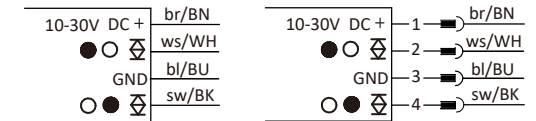
所有传感器功能必须符合电子和机械安全规定的法律法规
禁止直视激光束;
禁止把激光指向人;
请保持窗口面清洁, 以保证测量精度

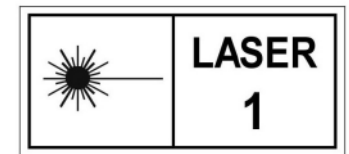

IEC 60825-1:2014
EN 60825-1:2014+A11:2021

模式设置：使用在背景抑制模式时，请参看以下安装及操作方法

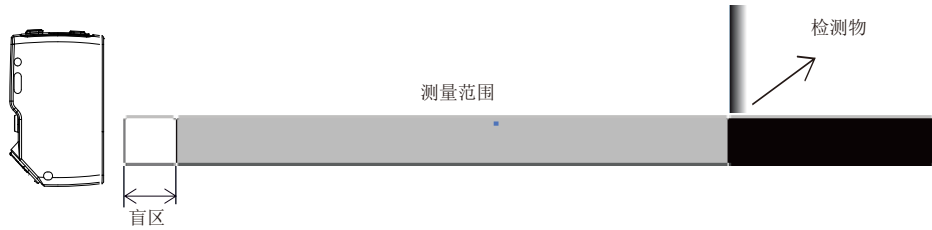

操作方法

在进入示教模式之前，按键不起作用

● 模式1：背景抑制模式设定

1.1 同时按下SET1和SET2大于2s，Q1、Q2同时闪烁，即可抬起按键

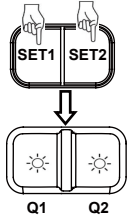

1.2 确认目标测试物放置到所需位置

①

1.3 按下SET1，Q1熄灭，Q2单次频闪，进入背景抑制阈值选取状态

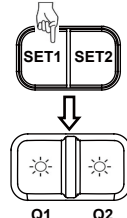

1.4 按下SET2，选取此时距离值，等待Q1闪烁一次，即设置成功，退出背景抑制设置模式，同时退出示教模式。如果1分钟内未进行操作，则退出示教模式。

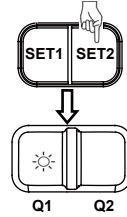

模式设置：使用在前景抑制模式时，请参看以下安装及操作方法

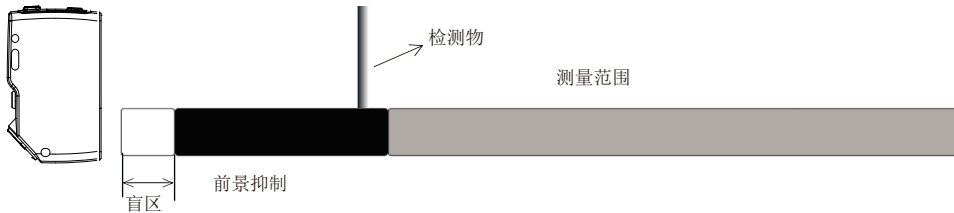

操作方法

在进入示教模式之前，按键不起作用

● 模式2：前景抑制模式设定

2.1 同时按下SET1和SET2大于2s，Q1、Q2同时闪烁，即可抬起按键

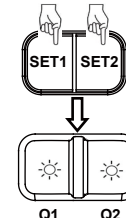

2.2 确认目标测试物放置到所需位置

②

2.3 连续按下两次SET1，Q1熄灭，Q2两次频闪，进入前景抑制阈值选取状态

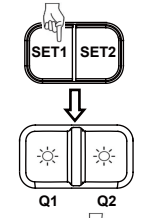

2.4 按下SET2，选取此时距离值，等待Q1闪烁一次，即设置成功，退出前景抑制设置模式，同时退出示教模式。如果1分钟内未进行操作，则退出示教模式。

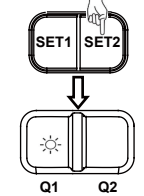

模式设置：使用在窗口模式时，请参看以下安装及操作方法

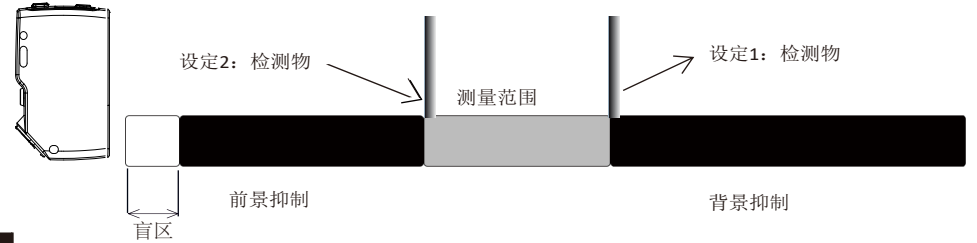

操作方法

在进入示教模式之前，按键不起作用

● 模式3：窗口模式设定

3.1 同时按下SET1和SET2大于2s，Q1、Q2同时闪烁，即可抬起按键

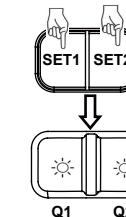

3.2 确认目标测试物放置到设定1的位置

3.3 连续按下三次SET1，Q1熄灭，Q2三次频闪，进入窗口阈值选取状态

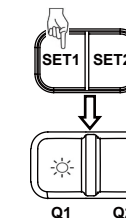

③

3.4 按下SET2，选取此时距离值作为最大值，等待Q1闪烁一次，即设置成功。如果1分钟内未进行操作，则退出示教模式。

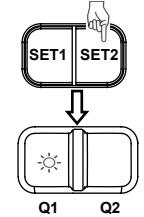

3.5 确认目标检测物防止到设定2的位置

3.6 按下SET2，选取此时距离值作为最小值，等待Q1闪烁一次，即设置成功，退出窗口设置模式，如果1分钟内未进行操作则退出示教模式。

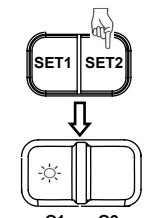

MODE SETTING: use in the background suppression mode, please refer to the following installation and operation method

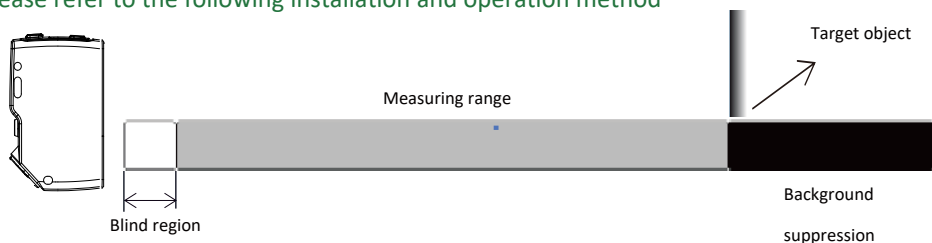

Operation method

Prior to entering the teaching mode, the buttons did not work.

● Mode1:Background suppression mode settings

1.1 At the same time press SET1 and SET2 more than 2s, Q1 and Q2 flashes at the same time, you can lift the button.

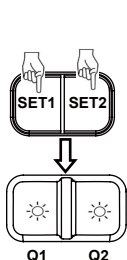

1.2 Verify that the target test object is placed in the desired location.

①

1.3 Press SET1, Q1 off, Q2 LED flashes one time. Entering the selection state of background suppression threshold.

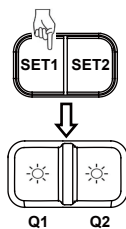

1.4 Press SET2 to select the distance value at this time. Wait Q1 flashes once, it means that the setting is successful, the setting mode of background suppression and the teaching mode is withdrawn. If there is no operation within 1 minutes, the teaching mode will be withdrawn.

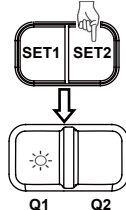

MODE SETTING: use in the foreground suppression mode, please refer to the following installation and operation method

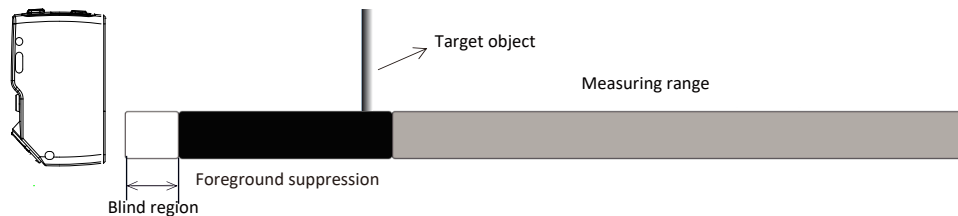

Operation method

Prior to entering the teaching mode, the buttons did not work.

● Mode2:suppression suppression mode settings

Tianjin Elco Automation Co.,Ltd / No.12, 4th XEDA Branch Rd,Xiqing Economic-Technological Development Area,Tianjin 300385,P.R.China

Tel: +86 22 23888288 / Fax: +86 22 23788399 / www.elco-holding.com.cn / Germany Tel: +49 70626599-260 / Germany Fax: +49 70626599-260 / Manufactured in china

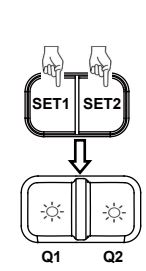
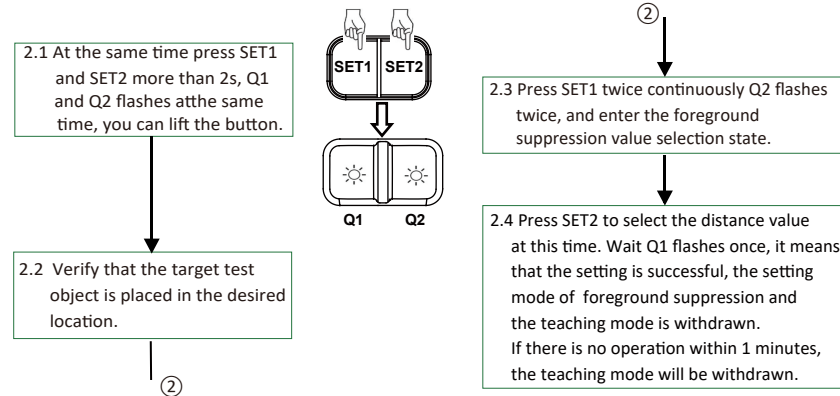

2.3 Press SET1 twice continuously Q2 flashes twice, and enter the foreground suppression value selection state.

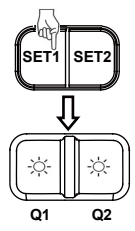

2.4 Press SET2 to select the distance value at this time. Wait Q1 flashes once, it means that the setting is successful, the setting mode of foreground suppression and the teaching mode is withdrawn. If there is no operation within 1 minutes, the teaching mode will be withdrawn.

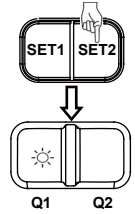

MODE SETTING: use in the window operation mode, please refer to the following installation and operation method

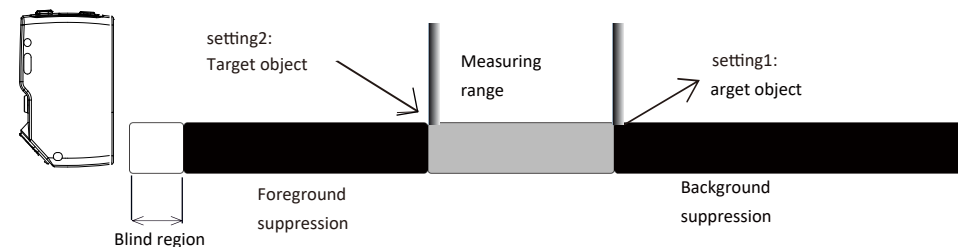

Operation method

Prior to entering the teaching mode, the buttons did not work.

● Mode 3:Window operating mode settings

3.1 At the same time press SET1 and SET2 more than 2s, Q1 and Q2 flashes at the same time, you can lift the button.

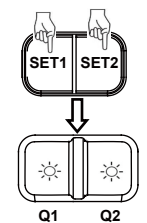

3.2 Verify that the target test object is placed at the setting1 location.

③

3.3 Three continuous press SET1, Q1 off, Q2 flashes three times threshold state. and enter the window

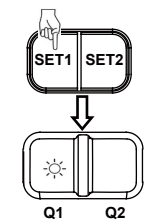

3.4 Press SET2 to select the distance value as the maximum value. Wait Q1 flashes once, it means that the setting is successful. If there is no operation within 1 minutes, the teaching mode will be withdrawn.

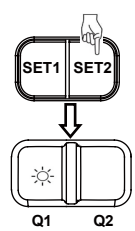

3.5 Verify that the target test object is placed at the setting 2 location.

3.6 Press SET2 to select the distance value as the minimum value. Wait Q1 flashes once, it means that the setting is successful, the setting mode of window operation and the teaching mode is withdrawn. If there is no operation within 1 minutes, the teaching mode will be withdrawn.

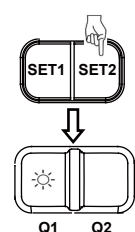

Tianjin Elco Automation Co.,Ltd / No.12, 4th XEDA Branch Rd,Xiqing Economic-Technological Development Area,Tianjin 300385,P.R.China

Tel: +86 22 23888288 / Fax: +86 22 23788399 / www.elco-holding.com.cn / Germany Tel: +49 70626599-260 / Germany Fax: +49 70626599-260 / Manufactured in china