

Product Description:

- Square size of 50*50, wide voltage supply, relay output.
- Suitable for garage, warehousing, logistics, crane collision and other applications.

Product features:

- Multiple output modes
- Long detection distance
- Flexible installation method

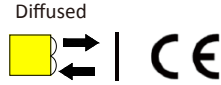
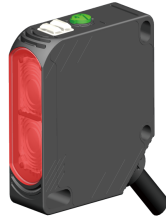

Type	Distance	Beam	Output	Connection	Wiring
OS50-K7000VP6 *M ¹⁾	7000mm	Infrared laser	PNP	Cable	Fig.1
OS50-K7000VP6Q	7000mm	Infrared laser	PNP	Connetor	Fig.2
OS50-K7000VN6 *M ¹⁾	7000mm	Infrared laser	NPN	Cable	Fig.3
OS50-K7000VN6Q	7000mm	Infrared laser	NPN	Connetor	Fig.4
OS50-K7000VR5 *M ¹⁾	7000mm	Infrared laser	Relay	Cable	Fig.5

Note 1): * M refers to the cable length in meters. If there is no * M in the model, the default cable length is 2 meters.

TECHNICAL SPECIFICATION

OPERATING VOLTAGE	10-30VDC(NPN/PNP) 24...240VDC/AC(Relay)	AMBIENT TEMPERATURE OPERATION	-10°C...+55°C
RIPPLE VOLTAGE	±10% of U _B	AMBIENT TEMPERATURE STORAGE	-40°C...+70°C
LIGHT SOURCE TYPE	Infrared laser	CIRCUIT PROTECTION	Short-circuit protection, reverse polarity protection, over-load protection
OUTPUT CHARACTERISTIC	PNP/NPN/Relay	PROTECTION DEGREE	IP67
LOAD CURRENT	≤200mA(NPN/PNP) ≤3A(Relay)	HOUSING MATERIAL	PBT+ABS
SWITCHING FREQUENCY	800Hz(NPN/PNP) 50HZ(Relay)	CONNECTING TYPE	*m PVC cable /M12 connector
ADJUSTMENT OF SENSITIVITY	Knob adjustment		

DIMENSIONS

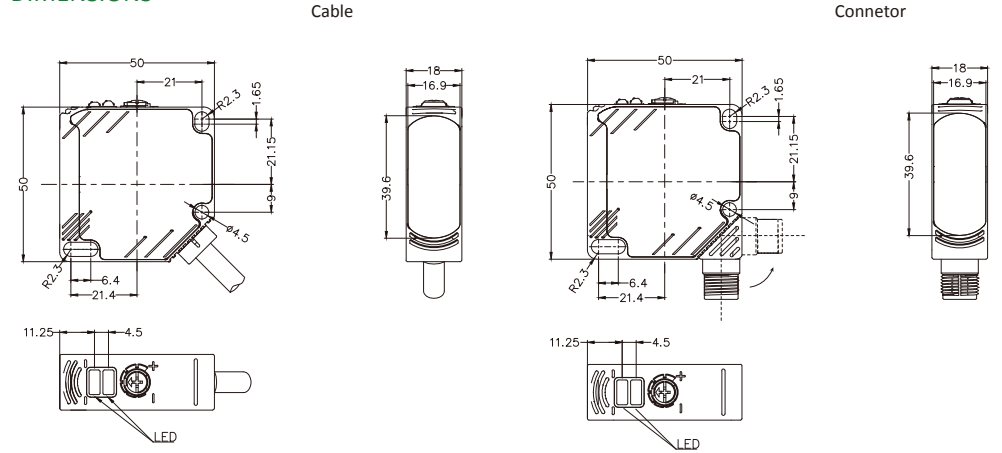

INDICATORS

Sensitivity adjustment knob	
steady state indicator	Green
Output indicator	Yellow

OS50-K7000 Spot pattern (mm)

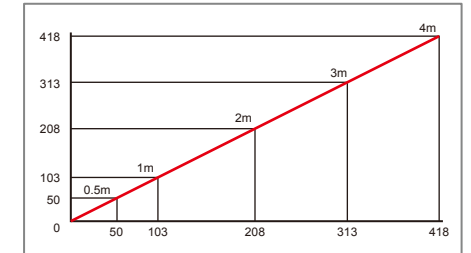

ELECTRICAL CONNECTION

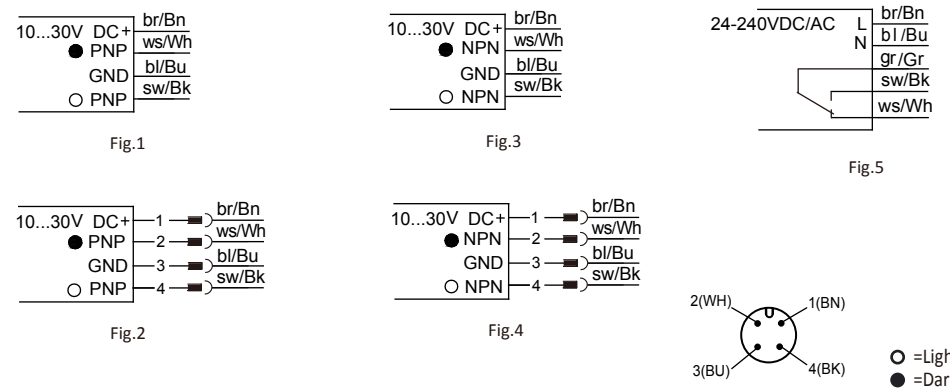

产品说明:

- 方形50*50尺寸, 宽电压供电, 继电器输出。
- 适用车库, 仓储, 物流, 天车防撞等应用。

产品特点:

- 多种输出模式
- 长检测距离
- 灵活的安装方式

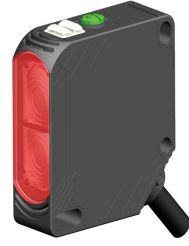

型号	检测距离	光源	输出方式	连接方式	接线图
OS50-K7000VP6 *M ¹⁾	7000mm	红外激光	PNP	线缆	图1
OS50-K7000VP6Q	7000mm	红外激光	PNP	M12 连接器	图2
OS50-K7000VN6 *M ¹⁾	7000mm	红外激光	NPN	线缆	图3
OS50-K7000VN6Q	7000mm	红外激光	NPN	M12 连接器	图4
OS50-K7000VR5 *M ¹⁾	7000mm	红外激光	继电器	线缆	图5

注1): *M表示线缆长度, 单位米, 型号中无*M默认线缆长度为2米。

技术参数

工作电压	10-30VDC(NPN/PNP) 24...240VDC/AC(继电器)	工作温度	-10°C...+55°C
纹波电压	±10% of U _B	环境温度	-40°C...+70°C
光源	红外激光	保护电路	短路保护 反极性保护 输出过载保护
输出特性	NPN/PNP/继电器	防护等级	IP67
负载电流	≤200mA(NPN/PNP) ≤3A(继电器)	外壳	ABS+PBT
开关频率	800Hz(NPN/PNP) 50HZ(继电器)	连接方式	*m PVC线缆 /M12连接器
灵敏度调节	旋钮调节		

外形尺寸

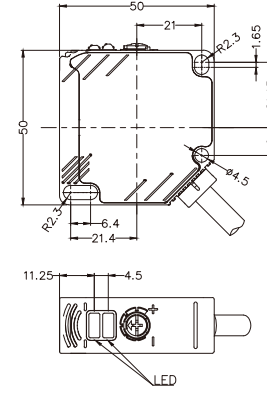

线缆

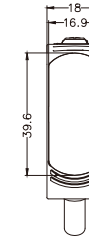

连接器

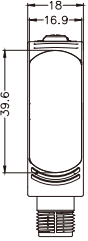
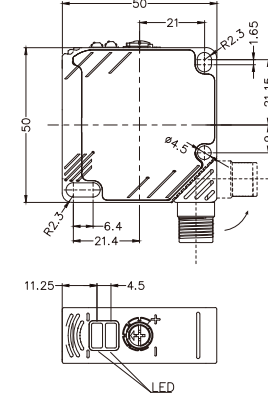

操作指示

灵敏度调节	
稳态指示灯	绿色
输出指示灯	黄色

OS50-K7000 光斑图 (mm)

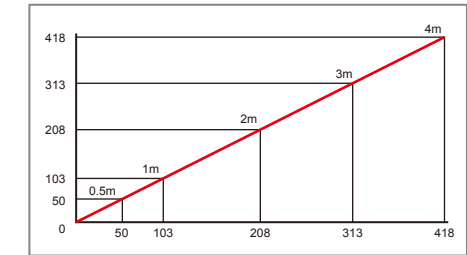

接线图



图1



图3

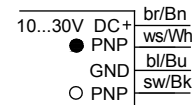

图5

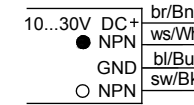

图2

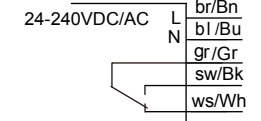

图4

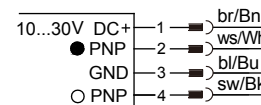
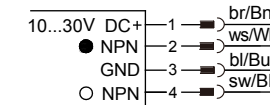