

Product Description:

- Square size of 50\*50, wide voltage supply, relay output.
- Suitable for garage, warehousing, logistics, crane collision and other applications.

Product features:

- Multiple output modes
- Long detection distance
- Flexible installation method

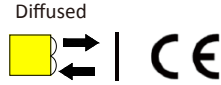
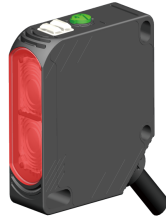

Type	Distance	Beam	Output	Connection	Wiring
OS50-K2500VP6 *M <sup>1)</sup>	2500mm	Infrared	PNP	Cable	Fig.1
OS50-K2500VP6Q	2500mm	Infrared	PNP	Connetor	Fig.2
OS50-K2500VN6 *M <sup>1)</sup>	2500mm	Infrared	NPN	Cable	Fig.3
OS50-K2500VN6Q	2500mm	Infrared	NPN	Connetor	Fig.4
OS50-K2500VR5 *M <sup>1)</sup>	2500mm	Infrared	Relay	Cable	Fig.5

Note 1): \* M refers to the cable length in meters. If there is no \* M in the model, the default cable length is 2 meters.

TECHNICAL SPECIFICATION

<b>OPERATING VOLTAGE</b>	10-30VDC(NPN/PNP) 24...240VDC/AC(Relay)	<b>AMBIENT TEMPERATURE OPERATION</b>	-25°C...+55°C
<b>RIPPLE VOLTAGE</b>	±10% of U <sub>B</sub>	<b>AMBIENT TEMPERATURE STORAGE</b>	-40°C...+70°C
<b>LIGHT SOURCE TYPE</b>	Infrared	<b>CIRCUIT PROTECTION</b>	Short-circuit protection, reverse polarity protection, over-load protection
<b>OUTPUT CHARACTERISTIC</b>	PNP/NPN/Relay	<b>PROTECTION DEGREE</b>	IP67
<b>LOAD CURRENT</b>	≤200mA(NPN/PNP) ≤3A(Relay)	<b>HOUSING MATERIAL</b>	PBT+ABS
<b>SWITCHING FREQUENCY</b>	800Hz(NPN/PNP) 50HZ(Relay)	<b>CONNECTING TYPE</b>	*m PVC cable /M12 connector
<b>ADJUSTMENT OF SENSITIVITY</b>	Knob adjustment		

DIMENSIONS

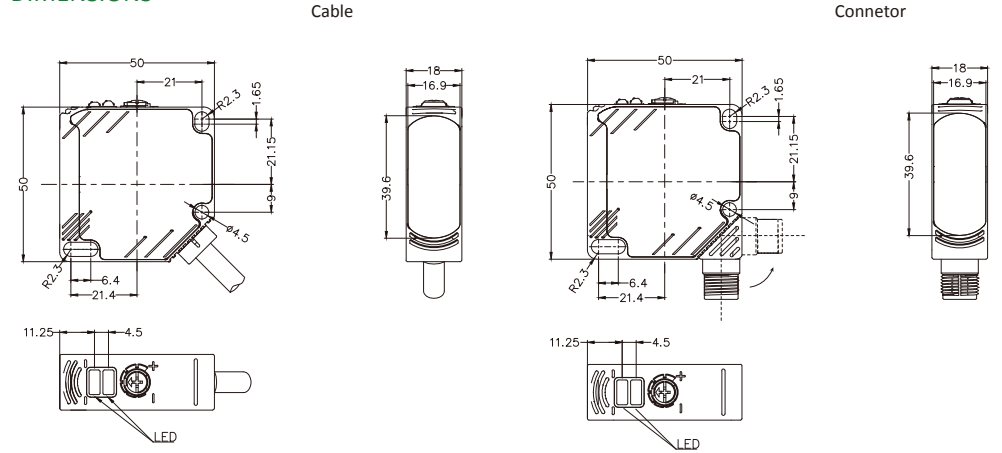

INDICATORS

Sensitivity adjustment knob	
steady state indicator	Green
Output indicator	Yellow

OS50-K2500 Spot pattern (mm)

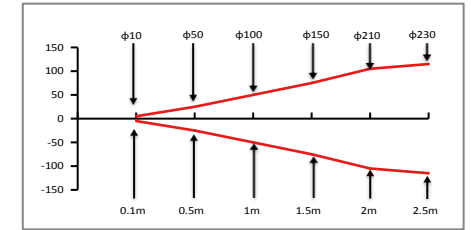

ELECTRICAL CONNECTION

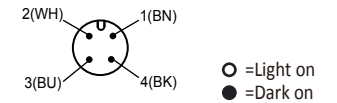
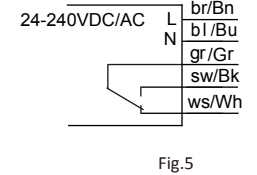
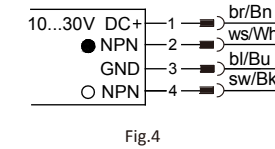
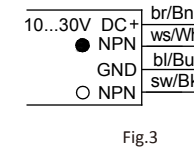
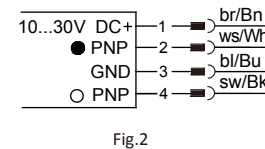
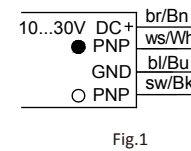

产品说明:

- 方形50\*50尺寸, 宽电压供电, 继电器输出。
- 适用车库, 仓储, 物流, 天车防撞等应用。

产品特点:

- 多种输出模式
- 长检测距离
- 灵活的安装方式



型号	检测距离	光源	输出方式	连接方式	接线图
OS50-K2500VP6 *M <sup>1)</sup>	2500mm	红外光	PNP	线缆	图1
OS50-K2500VP6Q	2500mm	红外光	PNP	M12 连接器	图2
OS50-K2500VN6 *M <sup>1)</sup>	2500mm	红外光	NPN	线缆	图3
OS50-K2500VN6Q	2500mm	红外光	NPN	M12 连接器	图4
OS50-K2500VR5 *M <sup>1)</sup>	2500mm	红外光	继电器	线缆	图5

注1): \*M表示线缆长度, 单位米, 型号中无\*M默认线缆长度为2米。

技术参数

工作电压	10-30VDC(NPN/PNP) 24...240VDC/AC(继电器)	工作温度	-25°C...+55°C
纹波电压	±10% of U <sub>B</sub>	环境温度	-40°C...+70°C
光源	红外光	保护电路	短路保护 反极性保护 输出过载保护
输出特性	NPN/PNP/继电器	防护等级	IP67
负载电流	≤200mA(NPN/PNP) ≤3A(继电器)	外壳	ABS+PBT
开关频率	800Hz(NPN/PNP) 50HZ(继电器)	连接方式	*m PVC线缆 /M12连接器
灵敏度调节	旋钮调节		

外形尺寸

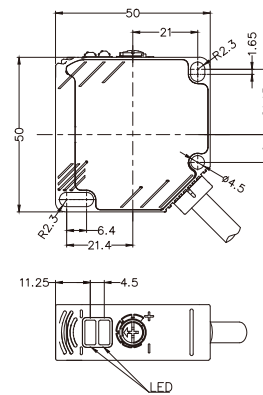

线缆

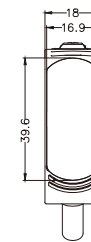

连接器

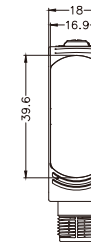
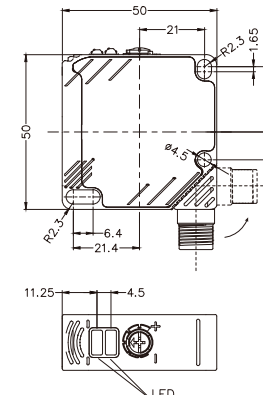

操作指示

灵敏度调节	
稳态指示灯	绿色
输出指示灯	黄色

OS50-K2500 光斑图 (mm)

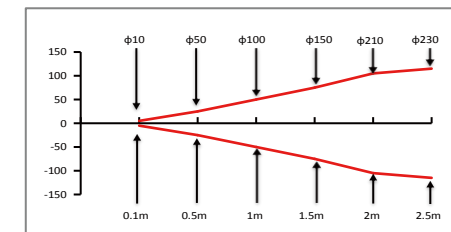

接线图



图1



图3

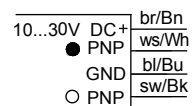

图5

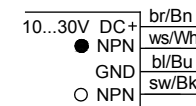

图2

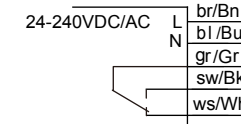

图4

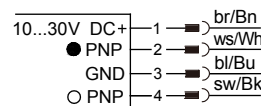
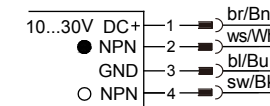
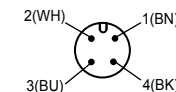

○ =亮通  
● =暗通