

# Photoelectric Sensors - Rectangular OS10



## Description:

Mini-rectangular photoelectric sensors OS10 series, with high performance and 25.4mm standard mounting hole distance, are available as BGS (background suppression) mode, diffused mode, retro-reflective mode, and opposed mode. With optional red beam or laser beam source, they are suitable for Mask machine, ATM machine, logistics transportation, new energy and other application fields.

## Features:

- BGS function greatly improves the detection effect
- Optional red beam or laser beam
- Adjustable sensing range
- Protection class IP67
- Optional M8 connector, 2 m pre-wired cable

## Type:

Detection mode	Type	Distance	Light source	Frequency	Output	Switching mode	Connection	Wiring		
Opposed	OS10-S6 (emitter)	30m	Infrared	— —	— —	— —	2m cable	Fig. 1		
	OS10-ECN6(receiver)		— —	800Hz	NPN	Light on/dark on	2m cable	Fig. 2		
	OS10-ECP6(receiver)		— —	800Hz	PNP	Light on/dark on	2m cable	Fig. 3		
		OS10-S6Q8(emitter)	30m	Infrared	— —	— —	— —	M8 connector, 4-pin	Fig. 4	
		OS10-ECN6Q8(receiver)		— —	800Hz	NPN	Light on/dark on	M8 connector, 4-pin	Fig. 5	
		OS10-ECP6Q8(receiver)		— —	800Hz	PNP	Light on/dark on	M8 connector, 4-pin	Fig. 6	
		OS10-S6/R (emitter)	25m	Red	— —	— —	— —	2m cable	Fig. 1	
		OS10-ECN6/R(receiver)		— —	800Hz	NPN	Light on/dark on	2m cable	Fig. 2	
		OS10-ECP6/R(receiver)		— —	800Hz	PNP	Light on/dark on	2m cable	Fig. 3	
			OS10-S6Q8/R(emitter)	25m	Red	— —	— —	— —	M8 connector, 4-pin	Fig. 4
			OS10-ECN6Q8/R(receiver)		— —	800Hz	NPN	Light on/dark on	M8 connector, 4-pin	Fig. 5
			OS10-ECP6Q8/R(receiver)		— —	800Hz	PNP	Light on/dark on	M8 connector, 4-pin	Fig. 6
Polarized retro-reflective	OS10-RPCN6	3m	Red	800Hz	NPN	Light on/dark on	2m cable	Fig. 2		
	OS10-RPCP6	3m	Red	800Hz	PNP	Light on/dark on	2m cable	Fig. 3		
	OS10-RPCN6Q8	3m	Red	800Hz	NPN	Light on/dark on	M8 connector, 4-pin	Fig. 5		
	OS10-RPCP6Q8	3m	Red	800Hz	PNP	Light on/dark on	M8 connector, 4-pin	Fig. 6		
Diffused	OS10-K1000CN6	20...1000mm	Red	800Hz	NPN	Light on/dark on	2m cable	Fig. 2		
	OS10-K1000CP6	20...1000mm	Red	800Hz	PNP	Light on/dark on	2m cable	Fig. 3		
	OS10-K1000CN6Q8	20...1000mm	Red	800Hz	NPN	Light on/dark on	M8 connector, 4-pin	Fig. 5		
	OS10-K1000CP6Q8	20...1000mm	Red	800Hz	PNP	Light on/dark on	M8 connector, 4-pin	Fig. 6		
BGS	OS10-AK65CN6	6...65mm	Red	400Hz	NPN	Light on/dark on	2m cable	Fig. 2		
	OS10-AK65CP6	6...65mm	Red	400Hz	PNP	Light on/dark on	2m cable	Fig. 3		
	OS10-AK65CN6Q8	6...65mm	Red	400Hz	NPN	Light on/dark on	M8 connector, 4-pin	Fig. 5		
	OS10-AK65CP6Q8	6...65mm	Red	400Hz	PNP	Light on/dark on	M8 connector, 4-pin	Fig. 6		
	OS10-AK150CN6	6...150mm	Red	400Hz	NPN	Light on/dark on	2m cable	Fig. 2		
	OS10-AK150CP6	6...150mm	Red	400Hz	PNP	Light on/dark on	2m cable	Fig. 3		
	OS10-AK150CN6Q8	6...150mm	Red	400Hz	NPN	Light on/dark on	M8 connector, 4-pin	Fig. 5		
	OS10-AK150CP6Q8	6...150mm	Red	400Hz	PNP	Light on/dark on	M8 connector, 4-pin	Fig. 6		

## Type:

Detection mode	Type	Distance	Light source	Frequency	Output	Switching mode	Connection	Wiring
BGS	OS10-AK350CN6	6...350mm	Red	400Hz	NPN	Light on/dark on	2m cable	Fig. 2
	OS10-AK350CP6	6...350mm	Red	400Hz	PNP	Light on/dark on	2m cable	Fig. 3
	OS10-AK350CN6Q8	6...350mm	Red	400Hz	NPN	Light on/dark on	M8 connector, 4-pin	Fig. 5
	OS10-AK350CP6Q8	6...350mm	Red	400Hz	PNP	Light on/dark on	M8 connector, 4-pin	Fig. 6
Opposed	OS10-SL6 (emitter)	30m	Laser	— —	— —	— —	2m cable	Fig. 1
	OS10-ELCN6 (receiver)		— —	800Hz	NPN	Light on/dark on	2m cable	Fig. 2
	OS10-ELCP6 (receiver)		— —	800Hz	PNP	Light on/dark on	2m cable	Fig. 3
	OS10-SL6Q8 (emitter)	30m	Laser	— —	— —	— —	M8 connector, 4-pin	Fig. 4
	OS10-ELCN6Q8 (receiver)		— —	800Hz	NPN	Light on/dark on	M8 connector, 4-pin	Fig. 5
	OS10-ELCP6Q8 (receiver)		— —	800Hz	PNP	Light on/dark on	M8 connector, 4-pin	Fig. 6
Polarized retro-reflective	OS10-RPLCN6	5m	Laser	800Hz	NPN	Light on/dark on	2m cable	Fig. 2
	OS10-RPLCP6	5m	Laser	800Hz	PNP	Light on/dark on	2m cable	Fig. 3
	OS10-RPLCN6Q8	5m	Laser	800Hz	NPN	Light on/dark on	M8 connector, 4-pin	Fig. 5
	OS10-RPLCP6Q8	5m	Laser	800Hz	PNP	Light on/dark on	M8 connector, 4-pin	Fig. 6
BGS	OS10-AKL150CN6	6...150mm	Laser	400Hz	NPN	Light on/dark on	2m cable	Fig. 2
	OS10-AKL150CP6	6...150mm	Laser	400Hz	PNP	Light on/dark on	2m cable	Fig. 3
	OS10-AKL150CN6Q8	6...150mm	Laser	400Hz	NPN	Light on/dark on	M8 connector, 4-pin	Fig. 5
	OS10-AKL150CP6Q8	6...150mm	Laser	400Hz	PNP	Light on/dark on	M8 connector, 4-pin	Fig. 6
	OS10-AKL350CN6	6...350mm	Laser	400Hz	NPN	Light on/dark on	2m cable	Fig. 2
	OS10-AKL350CP6	6...350mm	Laser	400Hz	PNP	Light on/dark on	2m cable	Fig. 3
	OS10-AKL350CN6Q8	6...350mm	Laser	400Hz	NPN	Light on/dark on	M8 connector, 4-pin	Fig. 5
	OS10-AKL350CP6Q8	6...350mm	Laser	400Hz	PNP	Light on/dark on	M8 connector, 4-pin	Fig. 6

## Technical Data:

Operating voltage	10...30VDC
Ripple voltage	≤10%
Light source	Red laser (650 nm)/class 1
Output type	PNP / NPN
Switch mode	Light on: Setting connects U+ Dark on: Setting connects U-
No-load current	≤20mA
load current	≤100mA
Sensitivity	Potentiometer adjustment
Output indicator	Red LED
Steady state indicator	Green LED
Housing	PC+PBT
Connection	M8 connector / 2m cable
Ambient temperature	-25 °C...+55 °C
Storage temperature	-40 °C...+70 °C
Protection class	IP67
Voltage withstanding	1000V/AC 50/60Hz 60s
Insulation impedance	≥50MΩ(500VDC)
Shock resistance	Complex amplitude 1.5mm 10... 50Hz (2hr X, Y,Z respectively)
Impact resistance	500m/S <sup>2</sup> (50G) 3 times X,Y,Z respectively

# Photoelectric Sensors - Rectangular OS10

## Product Features:

<p>Precise distance setting High resolution</p>	<p>Multi-turn potentiometer for accurate setting. Detect a workpiece with a thickness of up to 0.2 mm, such as a business card (the object to be tested is standard white).</p>
<p>BGS function</p>	<p>For workpieces of different colors and materials, the detection distance is basically the same. For a whiteboard with a reflectivity of 90% and a blackboard with a reflectivity of 6%, the distance attenuation is within 15%.</p>
<p>Small spot</p>	<p>The OS10-AKL150 series laser light source has a spot size of 1mm at 100mm position, which has the advantages of precise positioning and edge detection.</p>
<p>High brightness light source</p>	<p>High-brightness LED red light source for easy identification of detection positions</p>
<p>BGS</p>	<div style="display: flex; justify-content: space-around;"> <div data-bbox="532 909 956 1307"> <p>Distance Y (mm)</p> <p>Beam size X (mm)</p> <p>OS10-AKL150</p> </div> <div data-bbox="987 909 1411 1307"> <p>Distance Y (mm)</p> <p>Beam size X (mm)</p> <p>OS10-AK350</p> </div> </div>
<p>Resolution</p>	<div style="display: flex; justify-content: space-around;"> <div data-bbox="516 1705 922 2037"> <p>AK150</p> </div> <div data-bbox="987 1705 1393 2037"> <p>AK350</p> </div> </div>

### Attenuation figure:

OS10-K1000

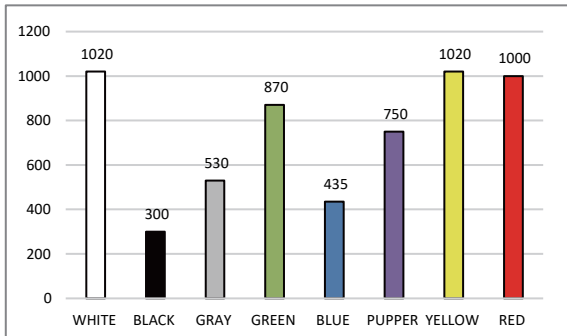

OS10-AK65

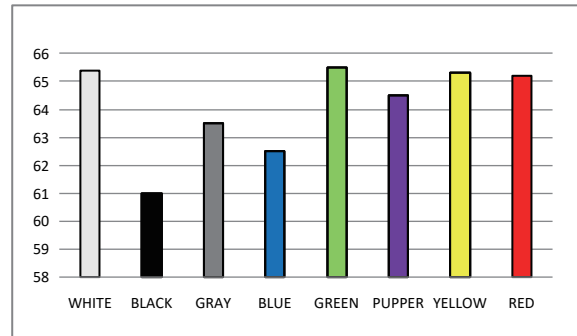

OS10-AK350

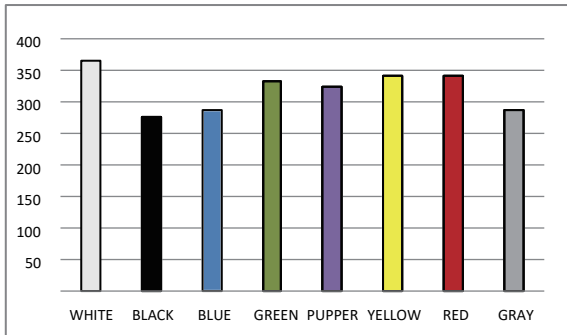

### Translation characteristic curve:

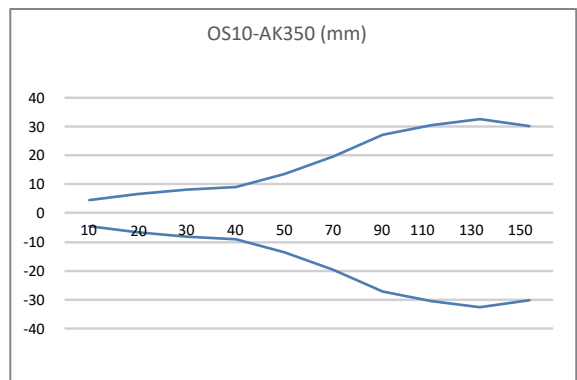
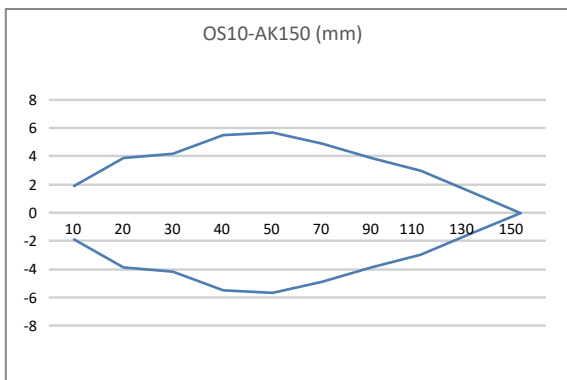
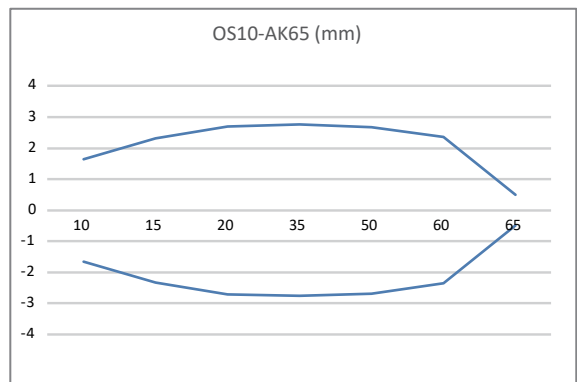
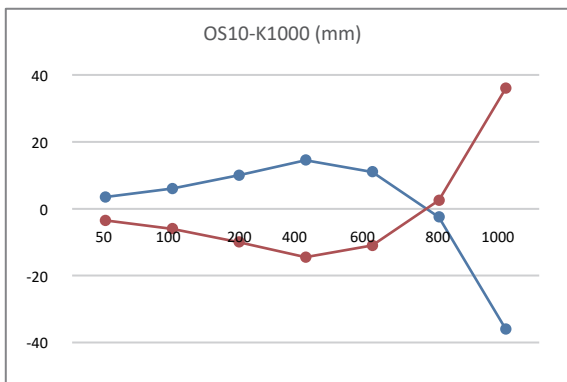

# Photoelectric Sensors - Rectangular OS10

## Beam Pattern :

OS10-S6 (mm)

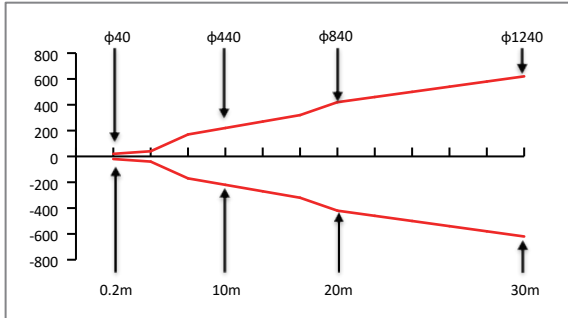

OS10-S6/R (mm)

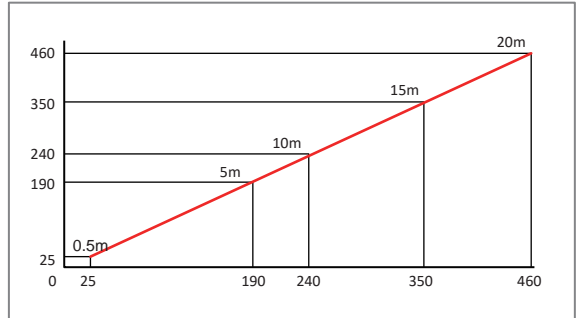

OS10--SL6 (mm)

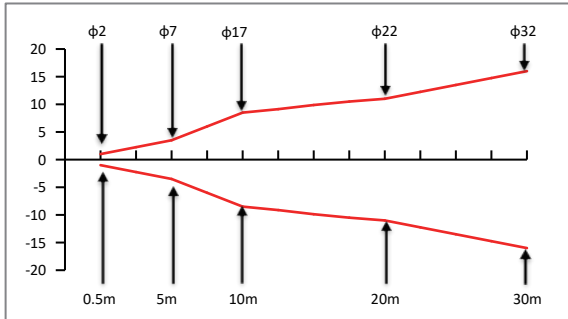

OS10-RP (mm)

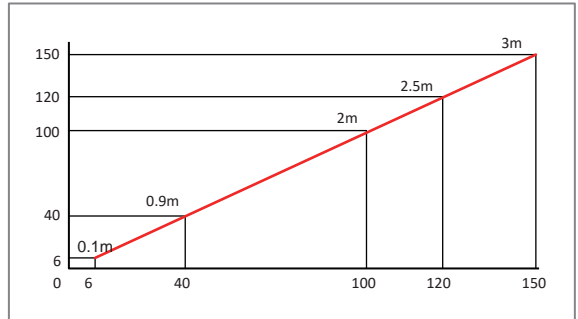

OS10-K1000 (mm)

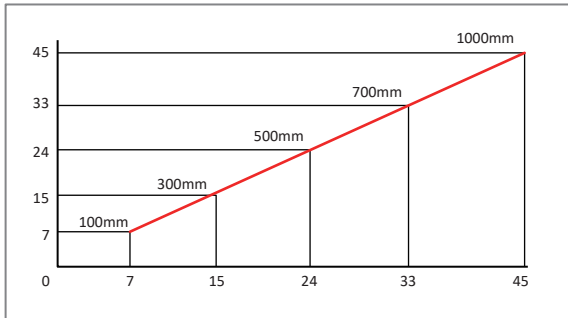

OS10-AK65 (mm)

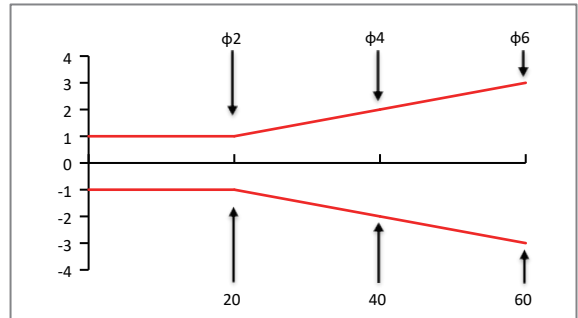

OS10-AK150 (mm)

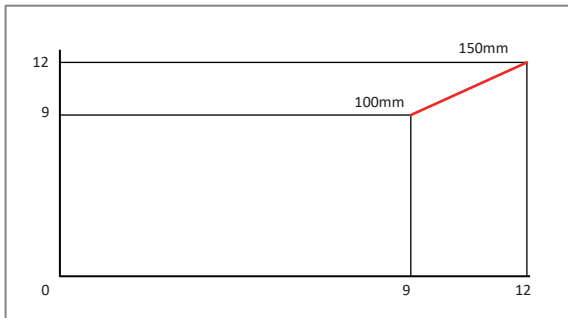

OS10-AK350 (mm)

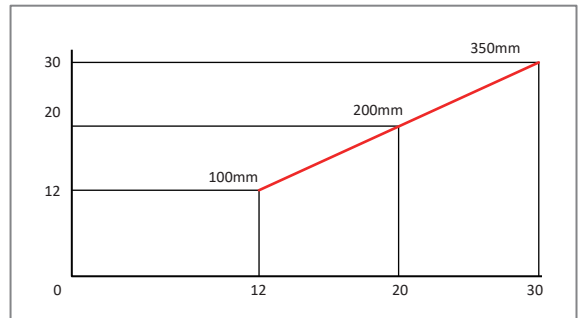

## Beam Pattern:

OS10-RPL (mm)

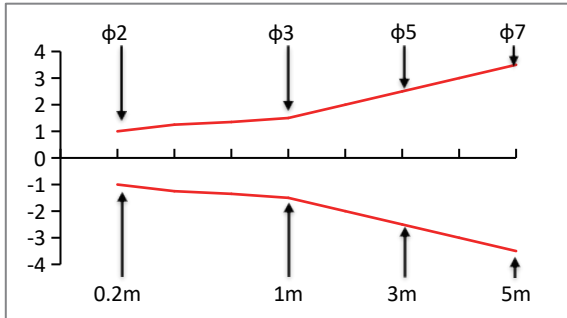

OS10S-AKL(AKL150|AKL350) (mm)

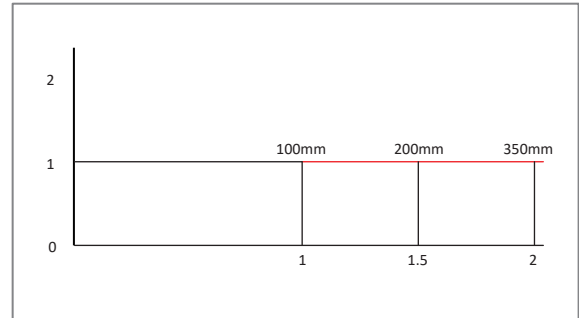

<p>BGS - Background Suppression Function:</p>	<div style="text-align: center;"> </div> <p style="text-align: center;">The sensor judges an present object when light is received at the receiver Red position.</p> <p>Standard diffused mode photoelectric sensors detect objects according to the value of the received light, which is dependent on object color, material, transparency and other factors. Therefore, even using the same type of diffused photoelectric sensor to detect different objects, the sensing ranges vary dramatically.</p> <p>By using dual diode receiver, the BGS mode photoelectric sensors detect the objects according to the different position that reflected light falls on the receiver. As shown in left figure, when the sensor is relatively close to the object, the reflected light falls on receiver Red position, at this time, the output is turned ON.</p> <p>The sensing range of the photoelectric sensors with BGS is basically the same for various objects.</p>						
<p>Laser polarizer reverse operation guide:</p>	<div style="text-align: center;"> </div> <table border="1" style="margin-left: auto; margin-right: auto;"> <tr> <td>Potentiometer</td> <td></td> </tr> <tr> <td>Output indicator</td> <td>Red LED</td> </tr> <tr> <td>Stable indicator</td> <td>Green LED</td> </tr> </table> <ol style="list-style-type: none"> <li>1. When the sensitivity is minimum, there is no response to the reflector or highlight objects.</li> <li>2. Place the reflector to the demanding position, slowly increase the sensitivity from the minimum, still the red and green LEDs are both on, and the setting is completed.</li> <li>3. When the sensitivity is maximum, if the product is triggered by the highlight object, the sensitivity needs to be reduced till the red and green LEDs turn on.</li> </ol>	Potentiometer		Output indicator	Red LED	Stable indicator	Green LED
Potentiometer							
Output indicator	Red LED						
Stable indicator	Green LED						

## Wiring:

### Cable

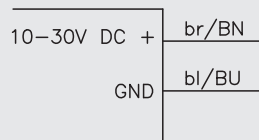

Fig. 1

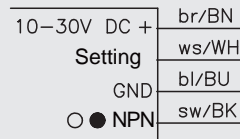

Fig. 2

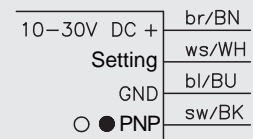

Fig. 3

### M8 connector

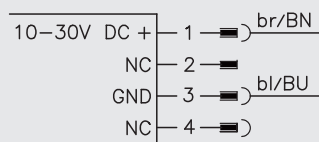

Fig. 4

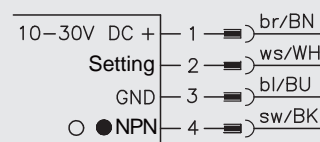

Fig. 5

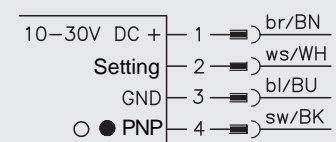
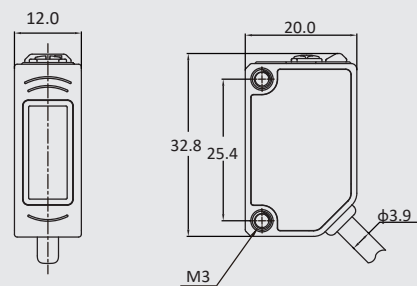

Fig. 6

## Dimensions:

### Cable



### M8 connector

