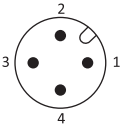

OG18 SERIES

ARTICLE PROPERTIES

SENSOR TYPE	Photoelectric sensor	CONNECTION TYPES (see table)
SIZE	M18x1	<ul style="list-style-type: none"> • Cable TPU, 0.15 mm², 2 m** • M12 connector
OPERATING DISTANCE	See table	
DETECTION MODE	Opposed, Retro-reflective, Polarized retro-reflective, Diffused, Fixed distance BGS	

** Other cable lengths are available on request

TECHNICAL DATA

OPERATING VOLTAGE	10 ... 30 V DC	VOLTAGE WITHSTANDING	1000 V/AC, 50/60 Hz, 60 s
RIPPLE VOLTAGE	≤ 10 %	REVERSE POLARITY PROTECTION	Yes
LIGHT SOURCE	Infrared light: 850 nm Red light: 650 nm	OVERLOAD RESISTANCE	Yes
LIGHT SPOT SIZE	See beam pattern	SHORT CIRCUIT PROTECTION	Yes
OUTPUT	PNP / NPN	MTTF	
FREQUENCY	See table	• Emitter	868 years
CURRENT CONSUMPTION	Opposed: ≤ 25 mA Others: ≤ 15 mA	• Receiver	472 years
LOAD CURRENT	≤ 200 mA	• Retro-reflective and diffused	439 years
HOUSING MATERIAL	PBT + ABS	• Polarized retro-reflective	177 years

ENVIRONMENTAL CONDITIONS

OPERATING ENVIRONMENT HUMIDITY	35 % to 85 % RH (no condensation)	INSULATION IMPEDENCE	≥ 50 MΩ (500 V DC)
PROTECTION CLASS	IP67	SHOCK RESISTANCE (EN 60068-2-27)	500 m/s ² (50 G) 3 times X, Y, Z respectively
STORAGE TEMPERATURE	-25 ... +55 °C	IMPACT RESISTANCE (EN 60068-2-6)	Complex amplitude 1.5 mm 10 ... 50 Hz (2hr X, Y, Z respectively)
AMBIENT TEMPERATURE	-40 ... +70 °C	ANTI-AMBIENT LIGHT	≤ 5000 Lux

STANDARDS AND DIRECTIVES

EMC DIRECTIVE 2014/30/EU	EN IEC 60947-5-2
ROHS DIRECTIVE 2011/65/EU	EN IEC 63000

APPROVALS



OG18 SERIES

DETECTION MODE OPPOSED

Article number	Operating distance	Light source	Frequency	Output (wiring diagram)	Switching mode	Connection	Dimensions
OG18-S6 (emitter)	30 m	Infrared light	— —	— — (WD1)	— —	2 m cable	see Fig. 1
OG18-ECP6 (receiver)	30 m	— —	800 Hz	PNP (WD2)	L.O / D.O	2 m cable	see Fig. 1
OG18-ECN6 (receiver)	30 m	— —	800 Hz	NPN (WD3)	L.O / D.O	2 m cable	see Fig. 1
OG18-S6Q (emitter)	30 m	Infrared light	— —	— — (WD6)	— —	M12 connector	see Fig. 2
OG18-ECP6Q (receiver)	30 m	— —	800 Hz	PNP (WD7)	L.O / D.O	M12 connector	see Fig. 2
OG18-ECN6Q (receiver)	30 m	— —	800 Hz	NPN (WD8)	L.O / D.O	M12 connector	see Fig. 2
OG18-S6/R (emitter)	30 m	Red	— —	— — (WD1)	— —	2 m cable	see Fig. 1
OG18-ECP6/R (receiver)	30 m	— —	800 Hz	PNP (WD2)	L.O / D.O	2 m cable	see Fig. 1
OG18-ECN6/R (receiver)	30 m	— —	800 Hz	NPN (WD3)	L.O / D.O	2 m cable	see Fig. 1
OG18-S6Q/R (emitter)	30 m	Red	— —	— — (WD6)	— —	M12 connector	see Fig. 2
OG18-ECP6Q/R (receiver)	30 m	— —	800 Hz	PNP (WD7)	L.O / D.O	M12 connector	see Fig. 2
OG18-ECN6Q/R (receiver)	30 m	— —	800 Hz	NPN (WD8)	L.O / D.O	M12 connector	see Fig. 2

DETECTION MODE RETRO-REFLECTIVE

(The detection distance corresponds to the reflector RB50*50-1 (purchased separately))

Article number	Operating distance	Light source	Frequency	Output (wiring diagram)	Switching mode	Connection	Dimensions
OG18-RCP6	4 m	Red	800 Hz	PNP (WD2)	L.O / D.O	2 m cable	see Fig. 1
OG18-RCN6	4 m	Red	800 Hz	NPN (WD3)	L.O / D.O	2 m cable	see Fig. 1
OG18-RCP6Q	4 m	Red	800 Hz	PNP (WD6)	L.O / D.O	M12 connector	see Fig. 2
OG18-RCN6Q	4 m	Red	800 Hz	NPN (WD7)	L.O / D.O	M12 connector	see Fig. 2

DETECTION MODE POLARIZED RETRO-REFLECTIVE

(The detection distance corresponds to the reflector RB50*50-1 (purchased separately))

Article number	Operating distance	Light source	Frequency	Output (wiring diagram)	Switching mode	Connection	Dimensions
OG18-RPCP6	4 m	Red	800 Hz	PNP (WD2)	L.O / D.O	2 m cable	see Fig. 1
OG18-RPCN6	4 m	Red	800 Hz	NPN (WD3)	L.O / D.O	2 m cable	see Fig. 1
OG18-RPCP6Q	4 m	Red	800 Hz	PNP (WD6)	L.O / D.O	M12 connector	see Fig. 2
OG18-RPCN6Q	4 m	Red	800 Hz	NPN (WD7)	L.O / D.O	M12 connector	see Fig. 2

OG18 SERIES

DETECTION MODE DIFFUSED

Article number	Operating distance	Light source	Frequency	Output (wiring diagram)	Switching mode	Connection	Dimensions
OG18-K200CP6	200 mm	Red	800 Hz	PNP (WD2)	L.O / D.O	2 m cable	see Fig. 1
OG18-K200CN6	200 mm	Red	800 Hz	NPN (WD3)	L.O / D.O	2 m cable	see Fig. 1
OG18-K200CP6Q	200 mm	Red	800 Hz	PNP (WD7)	L.O / D.O	M12 connector	see Fig. 2
OG18-K200CN6Q	200 mm	Red	800 Hz	NPN (WD8)	L.O / D.O	M12 connector	see Fig. 2
OG18-K400CP6	400 mm	Red	800 Hz	PNP (WD2)	L.O / D.O	2 m cable	see Fig. 1
OG18-K400CN6	400 mm	Red	800 Hz	NPN (WD3)	L.O / D.O	2 m cable	see Fig. 1
OG18-K400CP6Q	400 mm	Red	800 Hz	PNP (WD7)	L.O / D.O	M12 connector	see Fig. 2
OG18-K400CN6Q	400 mm	Red	800 Hz	NPN (WD8)	L.O / D.O	M12 connector	see Fig. 2
OG18-K600CP6	600 mm	Red	800 Hz	PNP (WD2)	L.O / D.O	2 m cable	see Fig. 1
OG18-K600CN6	600 mm	Red	800 Hz	NPN (WD3)	L.O / D.O	2 m cable	see Fig. 1
OG18-K600CP6Q	600 mm	Red	800 Hz	PNP (WD7)	L.O / D.O	M12 connector	see Fig. 2
OG18-K600CN6Q	600 mm	Red	800 Hz	NPN (WD8)	L.O / D.O	M12 connector	see Fig. 2

DETECTION MODE FIXED DISTANCE BGS

Article number	Operating distance	Light source	Frequency	Output (wiring diagram)	Switching mode	Connection	Dimensions
OG18-AK50VP6	5 ... 50 mm	Red	400 Hz	PNP (WD4)	L.O + D.O	2 m cable	see Fig. 1
OG18-AK50VN6	5 ... 50 mm	Red	400 Hz	NPN (WD5)	L.O + D.O	2 m cable	see Fig. 1
OG18-AK50VP6Q	5 ... 50 mm	Red	400 Hz	PNP (WD9)	L.O + D.O	M12 connector	see Fig. 2
OG18-AK50VN6Q	5 ... 50 mm	Red	400 Hz	NPN (WD10)	L.O + D.O	M12 connector	see Fig. 2
OG18-AK100VP6	8 ... 100 mm	Red	400 Hz	PNP (WD4)	L.O + D.O	2 m cable	see Fig. 1
OG18-AK100VN6	8 ... 100 mm	Red	400 Hz	NPN (WD5)	L.O + D.O	2 m cable	see Fig. 1
OG18-AK100VP6Q	8 ... 100 mm	Red	400 Hz	PNP (WD9)	L.O + D.O	M12 connector	see Fig. 2
OG18-AK100VN6Q	8 ... 100 mm	Red	400 Hz	NPN (WD10)	L.O + D.O	M12 connector	see Fig. 2
OG18-AK150VP6	10 ... 150 mm	Red	400 Hz	PNP (WD4)	L.O + D.O	2 m cable	see Fig. 1
OG18-AK150VN6	10 ... 150 mm	Red	400 Hz	NPN (WD5)	L.O + D.O	2 m cable	see Fig. 1
OG18-AK150VP6Q	10 ... 150 mm	Red	400 Hz	PNP (WD9)	L.O + D.O	M12 connector	see Fig. 2
OG18-AK150VN6Q	10 ... 150 mm	Red	400 Hz	NPN (WD10)	L.O + D.O	M12 connector	see Fig. 2
OG18-AK200VP6	10 ... 200 mm	Red	400 Hz	PNP (WD4)	L.O + D.O	2 m cable	see Fig. 1
OG18-AK200VN6	10 ... 200 mm	Red	400 Hz	NPN (WD5)	L.O + D.O	2 m cable	see Fig. 1
OG18-AK200VP6Q	10 ... 200 mm	Red	400 Hz	PNP (WD9)	L.O + D.O	M12 connector	see Fig. 2
OG18-AK200VN6Q	10 ... 200 mm	Red	400 Hz	NPN (WD10)	L.O + D.O	M12 connector	see Fig. 2

OG18 SERIES

WIRING DIAGRAMS Pre-wired cable

WD1 Emitter

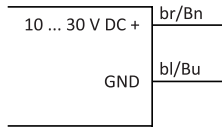

WD2 PNP / Light on | Dark on

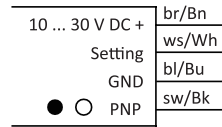

WD3 NPN / Light on | Dark on

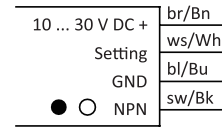

WD4 PNP / Light on | Dark on

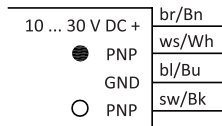

WD5 NPN / Light on | Dark on

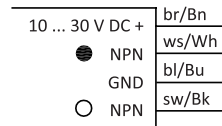

WIRING DIAGRAMS M12 connector

WD6 Emitter

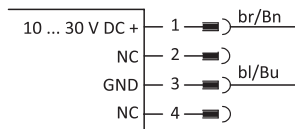

WD7 PNP / Light on | Dark on

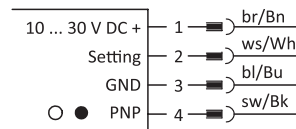

WD8 NPN / Light on | Dark on

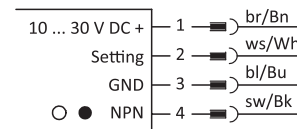

WD9 PNP / Light on | Dark on

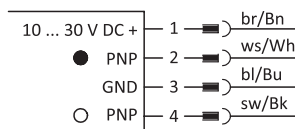

WD10 NPN / Light on | Dark on

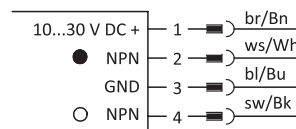

OG18 SERIES

ATTENUATION FIGURE

OG18-K200

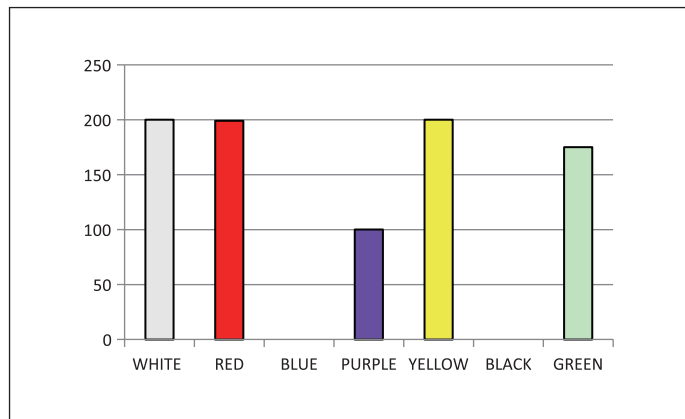

OG18-K600

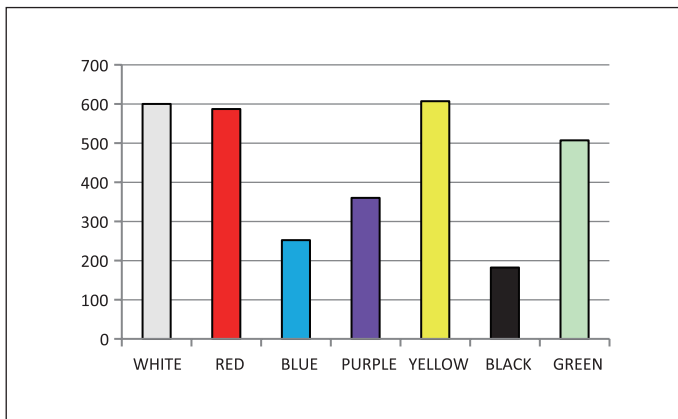

OG18-AK50

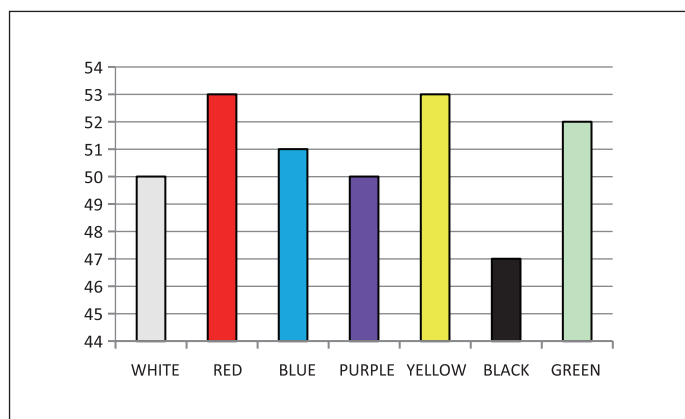

OG18-AK100

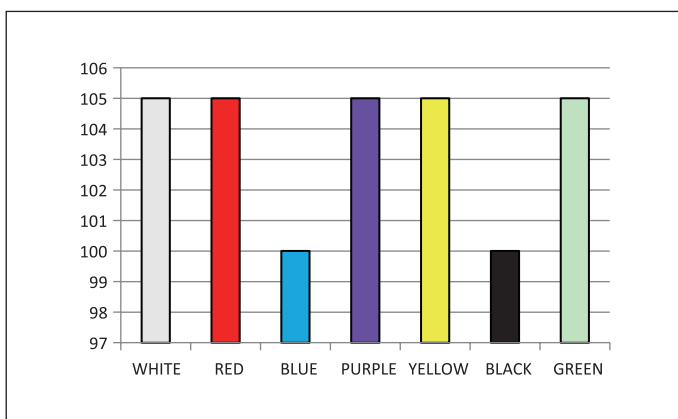

OG18-AK150

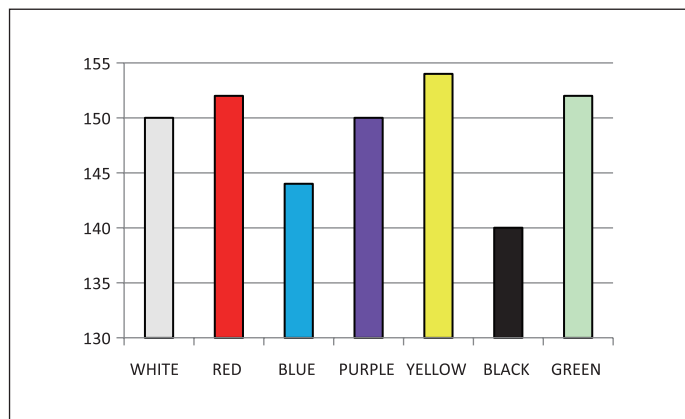

OG18-AK200

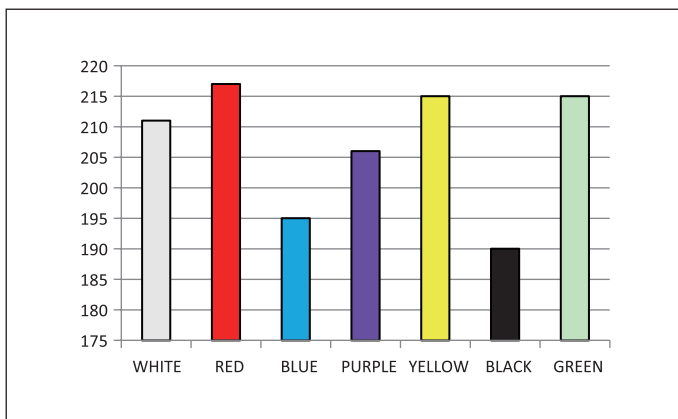

OG18 SERIES

TRANSLATION CHARACTERISTIC CURVE

OG18-S6 (mm)

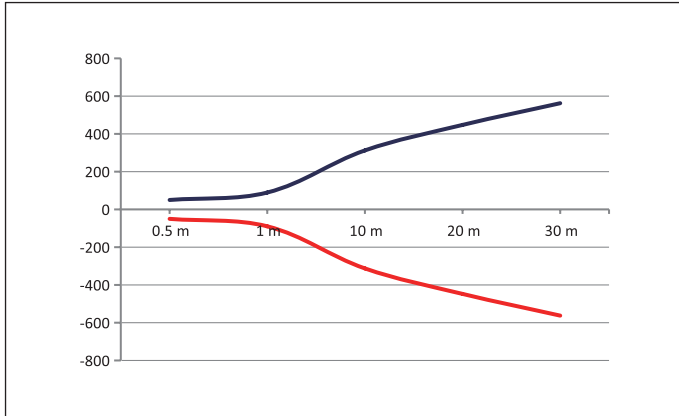

OG18-RCP6 (mm)

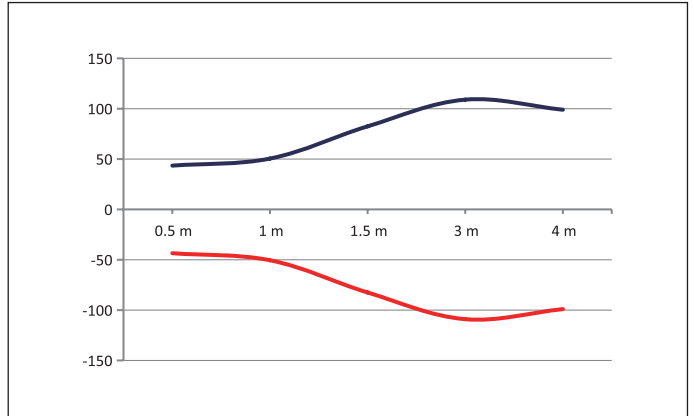

OG18-K200 (mm)

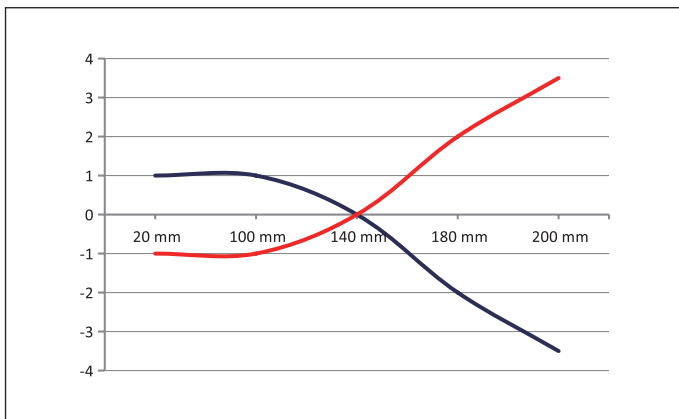

OG18-K600 (mm)

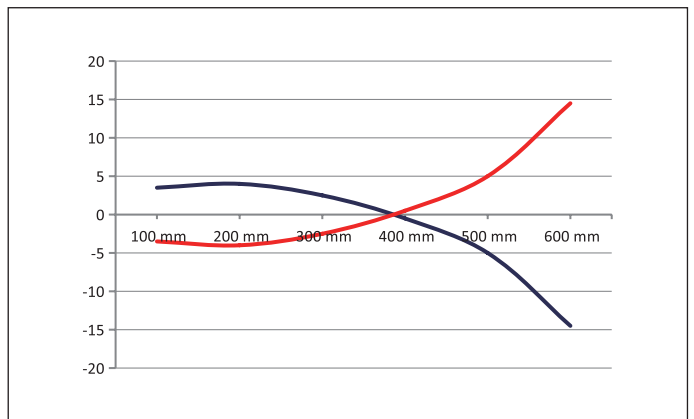

OG18-AK50 (mm)

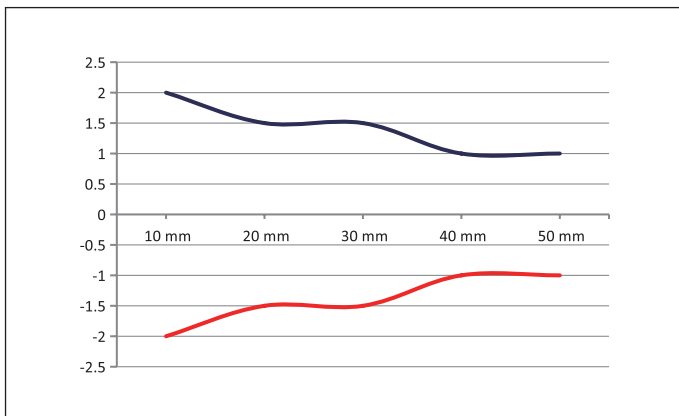

OG18-AK100 (mm)

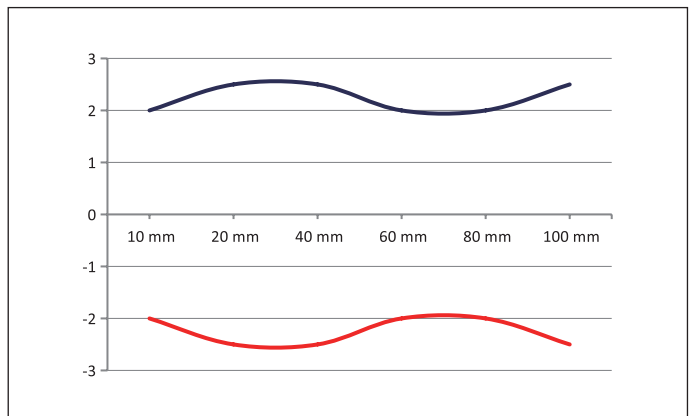

OG18 SERIES

TRANSLATION CHARACTERISTIC CURVE

OG18-AK150 (mm)

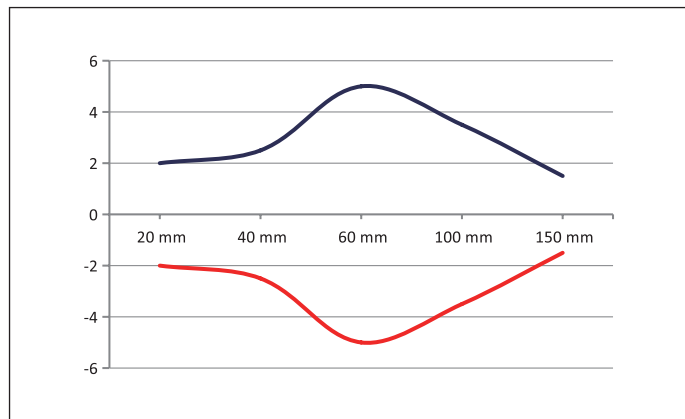

OG18-AK200 (mm)

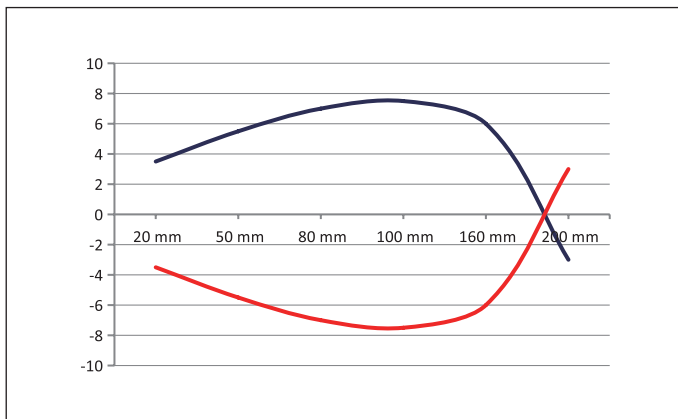

BEAM PATTERN

OG18-S6 (cm)

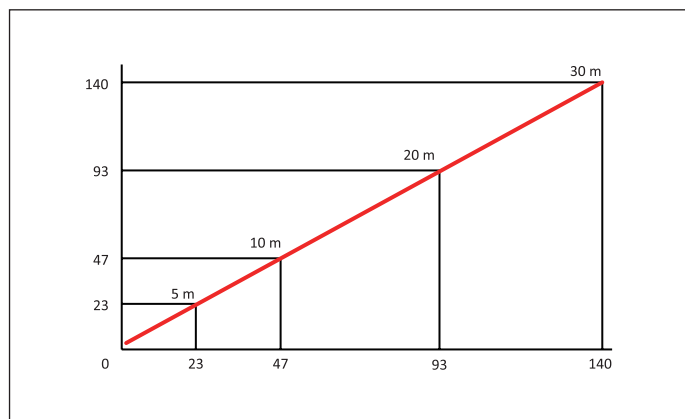

OG18-RP/R (mm)

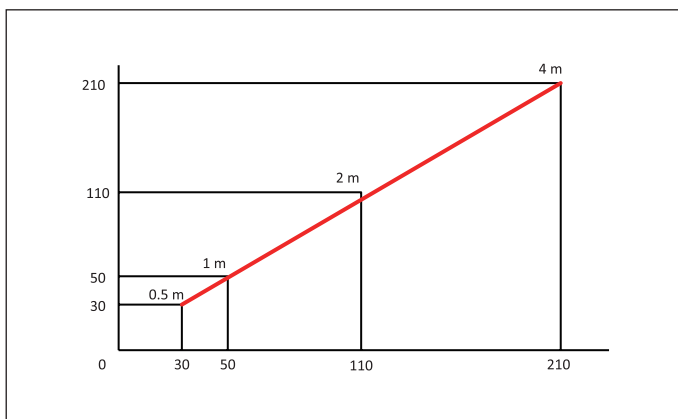

OG18-K (mm)

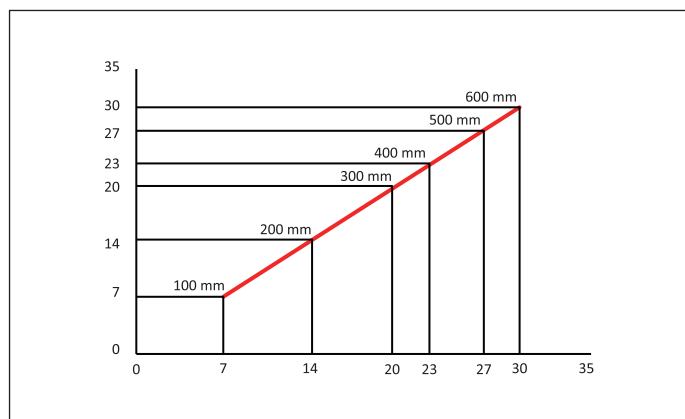

OG18-AK50/100 (mm)

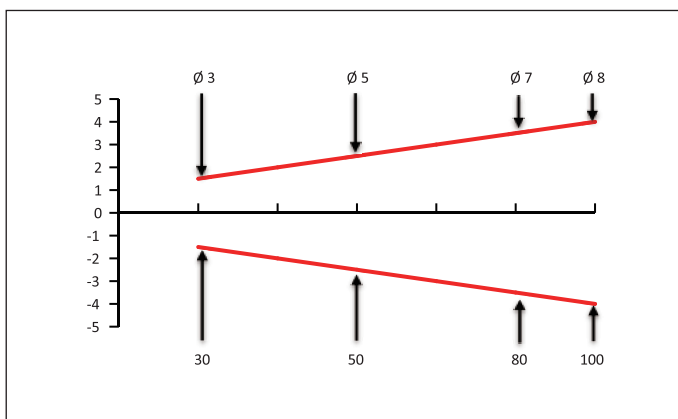

OG18 SERIES

BEAM PATTERN (mm)

OG18-AK150/200 (mm)

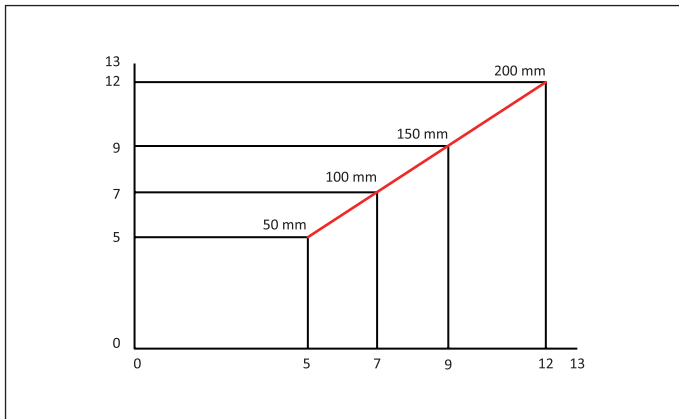

DIMENSIONS (mm)

Fig. 1 OG18 with cable

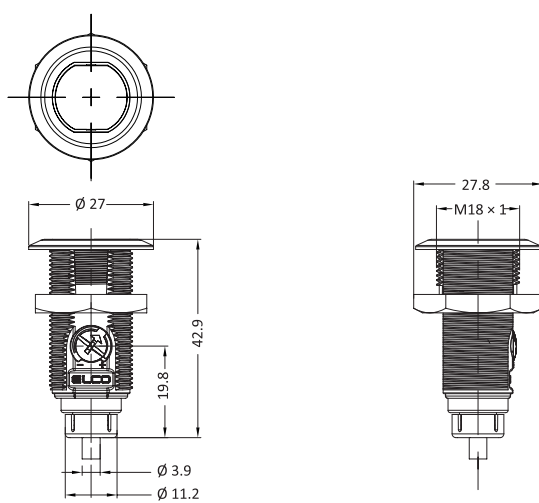
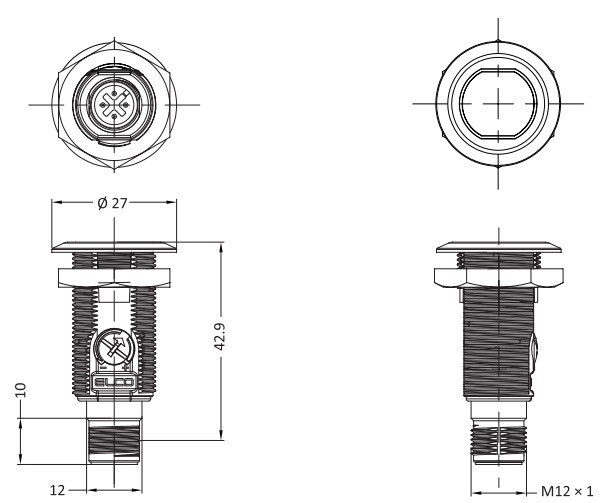

Fig. 2 OG18 with M12 connector



OG18 SERIES

MOUNTING BRACKET (STANDARD)

EOG18-1

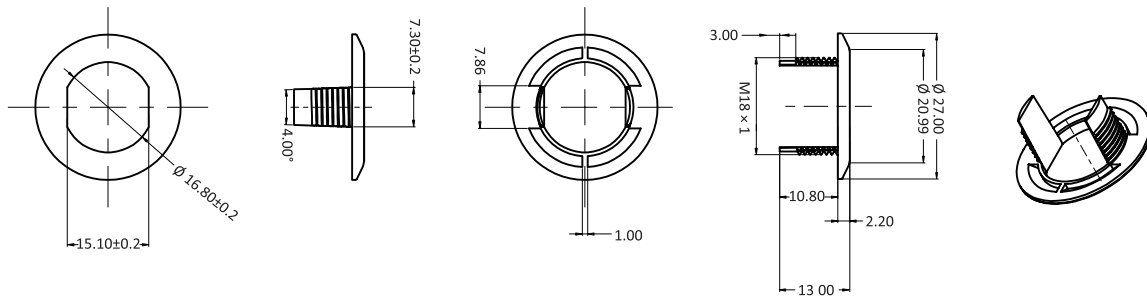

REFLECTOR (OPTIONAL)

RB50x50-1

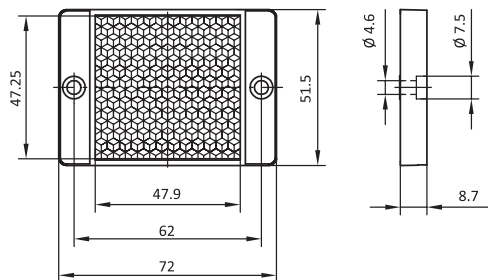

OG18 SERIES

SALES AND SERVICE

Tianjin Elco Automation Co., Ltd

No. 12, 4th XEDA Branch Road
Xiqing Economic-Technological Development Area
Tianjin 300385, P.R. China
Office Phone: 022 23788282
E-Mail: info@elco.cn
www.elco-holding.com.cn

Elco Industrie Automation GmbH

Benzstrasse 7
71720 Oberstenfeld,
Deutschland
Office Phone: +49 7062 / 6599-260
E-Mail: info@elco-automation.de
www.elco-automation.de

Elco Automation LLC

1097 Highway 101 South, Suite D-3 Greer
South Carolina 29651, USA
Office Phone: +1 864-581-7431
E-Mail: infousa@elcoautomation.com
www.elcoautomation.com

Elco Industrial Automation Pvt Ltd.

No 80, 1st Main, 2nd Cross, Royal Enclave,
Sidedahalli, Nagasandra Bangalore 560073, India
Office Phone: +91-7259931777
E-Mail: info@elcoautomation.in
www.elcoautomation.com

Elco Automation Korea Ltd.

706, 17 Daehak 4-ro, Yeongtong-gu, Suwon-si,
Gyeonggi-do, Republic of Korea, 16226
Office Phone: +82-31-216-7890
E-Mail: sales@elcoautomation.co.kr
www.elcoautomation.com