

INDUCTIVE POWER CLAMP SENSOR SERIES

ARTICLE PROPERTIES

SENSOR TYPE	Inductive sensor	CONNECTION TYPES (see table)
SIZE	47 x 18 mm	<ul style="list-style-type: none"> M12 connector, A-coded
RATED OPERATING DISTANCE	See table	
NUMBER OF CONDUCTORS	4-wire (see table)	

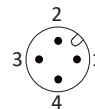

MECHANICAL DATA

MOUNTING (mounting nuts included in delivery)	Non-flush (see table)
HOUSING	Rectangular
MATERIAL HOUSING	PBT
MATERIAL SENSING SURFACE	PBT
TIGHTENING TORQUE LOCKING	---
STANDARD TEST	FE360
ATTENUATION COEFFICIENT	St37 = 1, V2A = 0.7, Al = 0.3

ELECTRICAL DATA

OPERATING VOLTAGE	DC: 10 ... 30 V DC
RATED OPERATING CURRENT	4-wire: ≤ 100 mA
SWITCHING FREQUENCY	See table
SWITCHING OUTPUT	See table
FUNCTION INDICATOR	Red / Green / Yellow LED
HYSTERESIS	3 ... 15 %
TEMPERATURE DRIFT	±10 %
SHORT-CIRCUIT PROTECTION	Yes
OVERLOAD RESISTANCE	Yes
REVERSE POLARITY PROTECTION	Yes

ENVIRONMENTAL CONDITIONS

PROTECTION CLASS	IP67	VIBRATION RESISTANCE (EN 60068-2-6)	10 ... 55 Hz, 1 mm
AMBIENT TEMPERATURE	-25 ... +70 °C	SHOCK RESISTANCE (EN 60068-2-27)	30 g, 11 ms

STANDARDS AND DIRECTIVES

EMC DIRECTIVE 2014/30/EU	EN IEC 60947-5-2
ROHS DIRECTIVE 2011/65/EU	EN IEC 63000

APPROVALS



INDUCTIVE POWER CLAMP SENSOR SERIES

DC 4-WIRE OUTPUT M12 CONNECTOR

Article number	Mounting	Rated operating distance Sn	Switching output (wiring diagram)	Switching frequency	Dimensions
NI2-QV2R1R2-OP6L-Q12	non-flush	2 mm	2 PNP NO (WD16)	200 Hz	see Fig. 1, 2, 3
NI2-QV2C1-OP6L-Q12	non-flush	2 mm	2 PNP NO (WD16)	200 Hz	see Fig. 1, 4

DIMENSIONS

Fig. 1 Processor

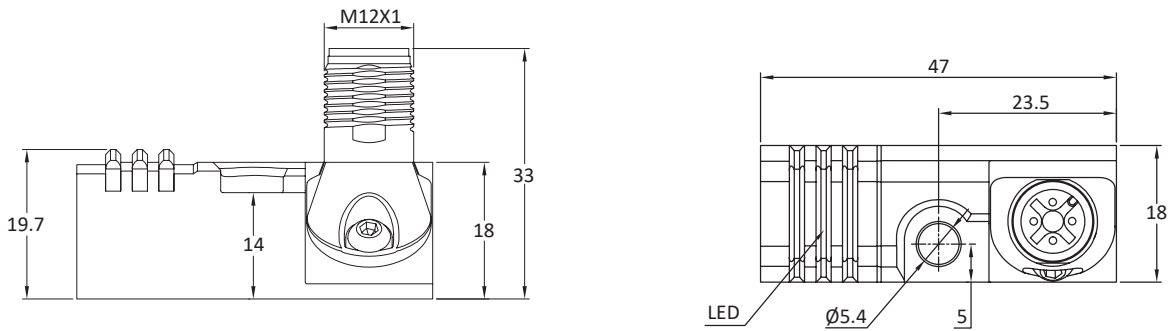

Fig. 2 Sensor head R1

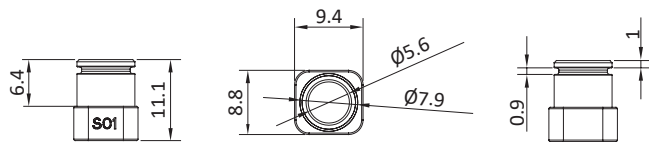

Fig. 3 Sensor head R2

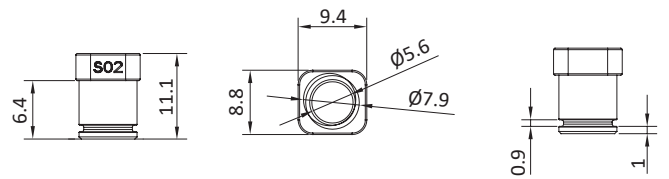
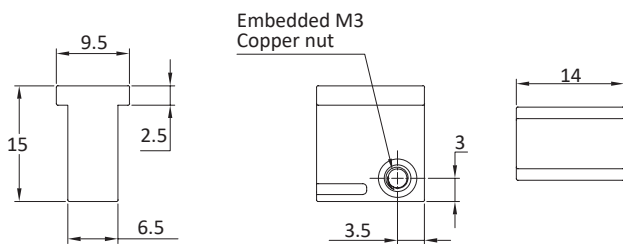

Fig. 4 Sensor head C1



INDUCTIVE POWER CLAMP SENSOR SERIES

WIRING DIAGRAMS (Note: 1 / 2 / 3 / 4 connector and terminals pin number Bn / Bu / Wh / Bk cable color)

WD1 DC 2-wire NO

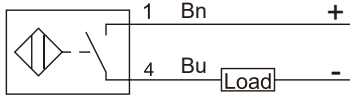

WD2 DC 2-wire NC

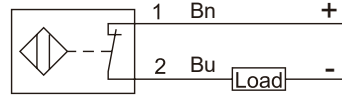

WD3 AC 2-wire NO

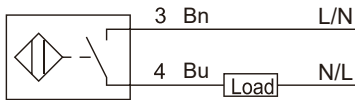

WD4 AC 2-wire NC

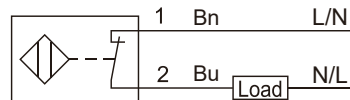

WD5 AC / DC 2-wire NO

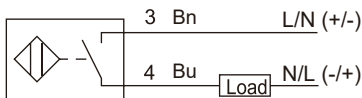

WD6 AC / DC 2-wire NC

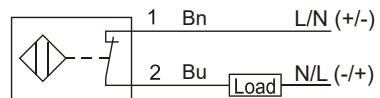

WD7 DC 3-wire PNP NO

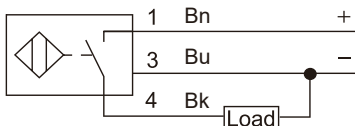

WD8 DC 3-wire NPN NO

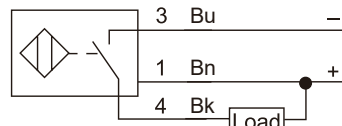

WD9 DC 3-wire PNP NC

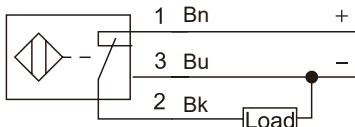

WD10 DC 3-wire NPN NC

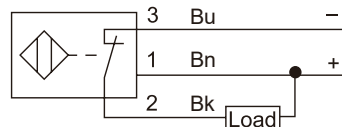

WD11 DC 4-wire PNP NO + NC

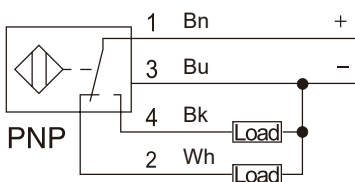

WD12 DC 4-wire NPN NO + NC

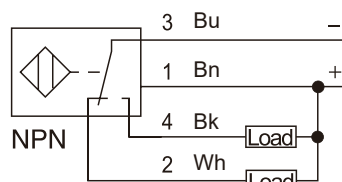

INDUCTIVE POWER CLAMP SENSOR SERIES

WIRING DIAGRAMS (Note: 1 / 2 / 3 / 4 connector and terminals pin number Bn / Bu / Wh / Bk cable color)

WD13 AC/DC 4-wire NO+NC

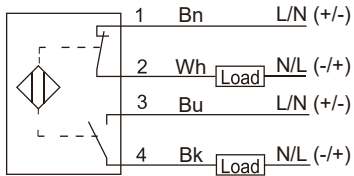

WD14 NAMUR 2-wire NC

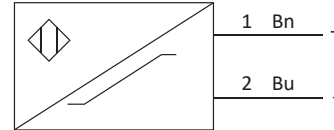

WD15 DC 4-wire 0-10V+0-20mA

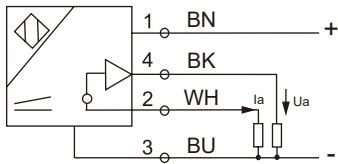

WD16 DC 4-wire 2 PNP NO

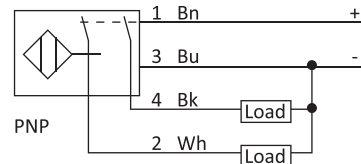

INDUCTIVE POWER CLAMP SENSOR SERIES

SALES AND SERVICE

Tianjin Elco Automation Co., Ltd

No. 12, 4th XEDA Branch Road
Xiqing Economic-Technological Development Area
Tianjin 300385, P.R. China
Office Phone: 022 23788282
E-Mail: info@elco.cn
www.elco-holding.com.cn

Elco Industrie Automation GmbH

Benzstrasse 7
71720 Oberstenfeld,
Deutschland
Office Phone: +49 7062 / 6599-260
E-Mail: info@elco-automation.de
www.elco-automation.de

Elco Automation LLC

1097 Highway 101 South, Suite D-3 Greer
South Carolina 29651, USA
Office Phone: +1 864-581-7431
E-Mail: infousa@elcoautomation.com
www.elcoautomation.com

Elco Industrial Automation Pvt Ltd.

No 80, 1st Main, 2nd Cross, Royal Enclave,
Sidedahalli, Nagasandra Bangalore 560073, India
Office Phone: +91-7259931777
E-Mail: info@elcoautomation.in
www.elcoautomation.com

Elco Automation Korea Ltd.

706, 17 Daehak 4-ro, Yeongtong-gu, Suwon-si,
Gyeonggi-do, Republic of Korea, 16226
Office Phone: +82-31-216-7890
E-Mail: sales@elcoautomation.co.kr
www.elcoautomation.com