

C80 NAMUR SERIES

ARTICLE PROPERTIES

SENSOR TYPE	Inductive sensor	CONNECTION TYPES (see table)	
SIZE	80 x 80 x 40 mm	• Terminals	For cables with wire cross-section up to 2.5 mm ² , cable gland M20x1.5
RATED OPERATING DISTANCE	See table		
NUMBER OF CONDUCTORS	2-wire (see table)		

MECHANICAL DATA

MOUNTING	Flush / non-flush (see table)
HOUSING	Rectangular
MATERIAL HOUSING	PBT
MATERIAL SENSING SURFACE	PBT
TIGHTENING TORQUE LOCKING	1.8 N·m
STANDARD TEST	FE360
ATTENUATION COEFFICIENT	St37 = 1, V2A = 0.7, Al = 0.3

ELECTRICAL DATA

OPERATING VOLTAGE	DC: 7.7 ... 9 V DC
RATED OPERATING CURRENT	2-wire: ≤ 1 mA (trigger) ≥ 2.2 mA (not trigger)
SWITCHING FREQUENCY	See table
SWITCHING OUTPUT	See table
FUNCTION INDICATOR	Yellow LED
HYSTERESIS	3 ... 15 %
TEMPERATURE DRIFT	±10 %
SHORT-CIRCUIT PROTECTION	Yes
OVERLOAD RESISTANCE	Yes
REVERSE POLARITY PROTECTION	Yes

ENVIRONMENTAL CONDITIONS

PROTECTION CLASS	IP67	VIBRATION RESISTANCE (EN 60068-2-6)	10 ... 55 Hz, 1 mm
AMBIENT TEMPERATURE	-25 ... +70 °C	SHOCK RESISTANCE (EN 60068-2-27)	30 g, 11 ms

STANDARDS AND DIRECTIVES

EMC DIRECTIVE 2014/30/EU	EN IEC 60947-5-2
ROHS DIRECTIVE 2011/65/EU	EN IEC 63000

APPROVALS



C80 NAMUR SERIES

DC 2-WIRE OUTPUT TERMINALS

Article number	Mounting	Rated operating distance Sn	Switching output (wiring diagram)	Switching frequency	Dimensions
Fi40-C80-NE	flush	40 mm	NAMUR NC (WD14)	80 Hz	see Fig. 1
Ni50-C80-NE	non-flush	50 mm	NAMUR NC (WD14)	100 Hz	see Fig. 1

DIMENSIONS

Fig. 1 Inductive sensor with terminals (flush/non-flush)

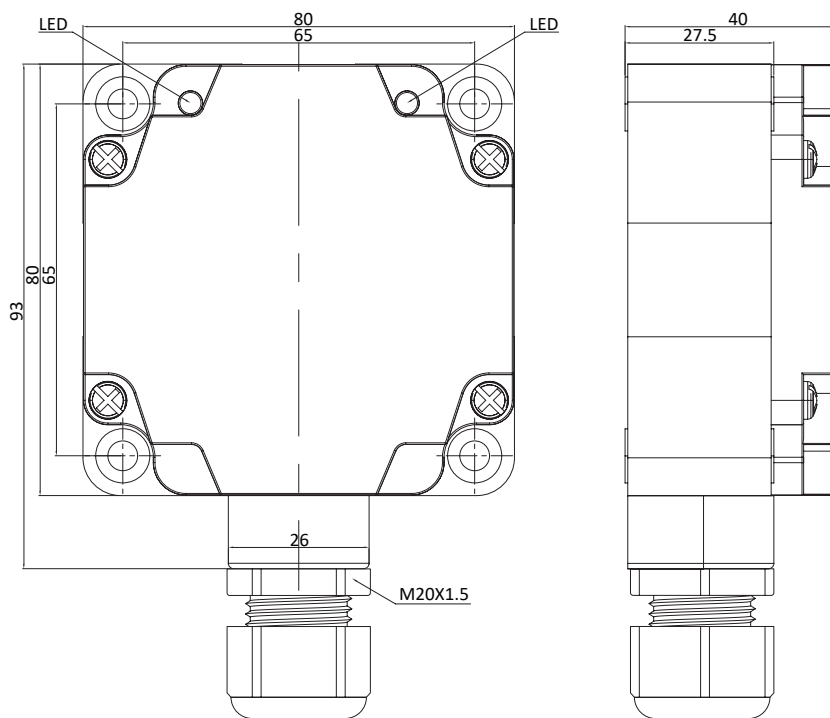

C80 NAMUR SERIES

WIRING DIAGRAMS (Note: 1 / 2 / 3 / 4 connector and terminals pin number Bn / Bu / Wh / Bk cable color)

WD1 DC 2-wire NO

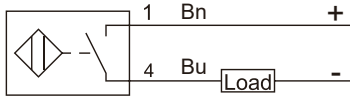

WD2 DC 2-wire NC

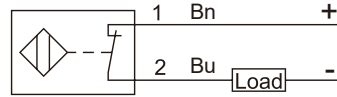

WD3 AC 2-wire NO

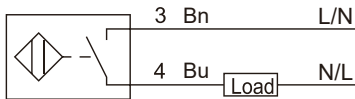

WD4 AC 2-wire NC

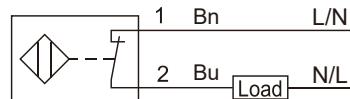

WD5 AC / DC 2-wire NO

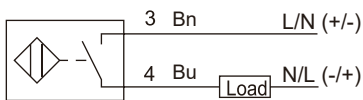

WD6 AC / DC 2-wire NC

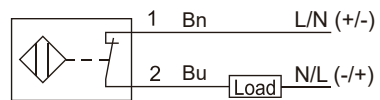

WD7 DC 3-wire PNP NO

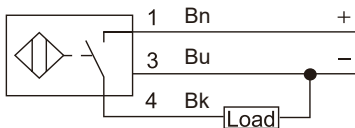

WD8 DC 3-wire NPN NO

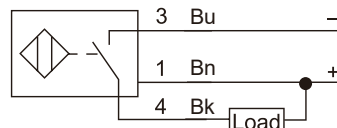

WD9 DC 3-wire PNP NC

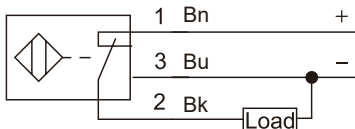

WD10 DC 3-wire NPN NC

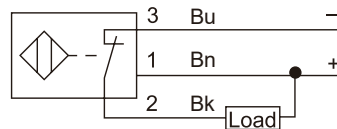

WD11 DC 4-wire PNP NO + NC

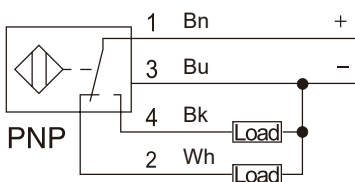

WD12 DC 4-wire NPN NO + NC

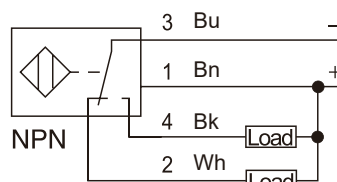

C80 NAMUR SERIES

WIRING DIAGRAMS (Note: 1 / 2 / 3 / 4 connector and terminals pin number Bn / Bu / Wh / Bk cable color)

WD13 AC/DC 4-wire NO+NC

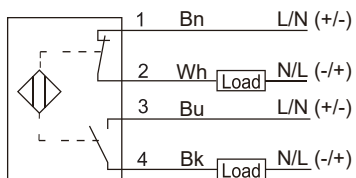

WD14 NAMUR 2-wire NC

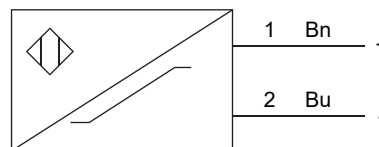

WD15 DC 4-wire 0-10V+0-20mA

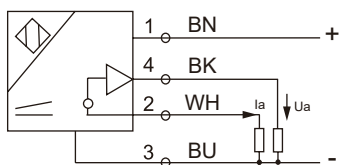

C80 NAMUR SERIES

SALES AND SERVICE

Tianjin Elco Automation Co., Ltd

No. 12, 4th XEDA Branch Road
Xiqing Economic-Technological Development Area
Tianjin 300385, P.R. China
Office Phone: 022 23788282
E-Mail: info@elco.cn
www.elco-holding.com.cn

Elco Industrie Automation GmbH

Benzstrasse 7
71720 Oberstenfeld,
Deutschland
Office Phone: +49 7062 / 6599-260
E-Mail: info@elco-automation.de
www.elco-automation.de

Elco Automation LLC

1097 Highway 101 South, Suite D-3 Greer
South Carolina 29651, USA
Office Phone: +1 864-581-7431
E-Mail: infousa@elcoautomation.com
www.elcoautomation.com

Elco Industrial Automation Pvt Ltd.

No 80, 1st Main, 2nd Cross, Royal Enclave,
Sidedahalli, Nagasandra Bangalore 560073, India
Office Phone: +91-7259931777
E-Mail: info@elcoautomation.in
www.elcoautomation.com

Elco Automation Korea Ltd.

706, 17 Daehak 4-ro, Yeongtong-gu, Suwon-si,
Gyeonggi-do, Republic of Korea, 16226
Office Phone: +82-31-216-7890
E-Mail: sales@elcoautomation.co.kr
www.elcoautomation.com